

Olof Alexandersson

# LIVING WATER

*Viktor Schauberger and the Secrets of Natural Energy*

# CONTENTS

	Page
Publisher's Note	8
List of illustrations	9
Foreword by Kai Curry-Lindahl	11
Introduction	13
Chapter	
1. Who Was Viktor Schaubberger?	17
2. New Techniques of Water Management	39
3. Schaubberger's Teachings on Water	50
4. The Life and Death of a Forest	66
5. Perpetual Motion	76
6. Implosion and Biosynthesis	83
7. A Meeting With Hitler	88
8. Wartime Experiences	92
9. Biological Techniques in Agriculture	96
10 Schaubberger's Criticism of Science and Society	111
11 The Final Years	116
12 Schaubberger's Heritage	124
13 The Spreading Scientific Search	129
Appendix I Contemporary Applications of Vortex Research	141
Appendix II Physics and The Vortex	150
Notes	152
Bibliography	158
Index	161

## PUBLISHER'S NOTE

The first English language publication of this title in 1982 attracted much curiosity, but there were not, at that time, many projects in vortex research. Awareness of the world ecological crisis has stimulated much creative thought, so we considered it relevant to add some new material. The appendices therefore contribute information on new research projects and on the links of vortex theory to fundamental physics.

# LIST OF ILLUSTRATIONS

1. Viktor Schauburger	16
2. Grass Snake Swimming	26
3. Log Flumes at Neuberg	30
4. Water Disturbance Patterns	35
5. Natural River Profiles	38
6. Flood Control Scheme	42
7. The Dying Rhine	46
8. 'Energy Bodies' placed in a Stream	48
9. Motion Within a Water Droplet	51
10. A Mountain Stream	57
11. 'Living Water' Machine, Mk. I	60
12. 'Living Water' Machine, Mk. II	62
13. Swedish Biological Synthesising Machine	63
14. Double Spiral Pipe	64
15. Ground Preparation after Tree Felling	70
16. A Polluted River	78
17. Pipes for Liquids and Gas	86
18. The Nurnberg Experiment	90
19. The Domestic Power Station	91
20. Models of Flying Saucers	95
21. Heart of a Cockchafer	99
22. The Spiral Plow	104
23. 'Noble' Compost Heap	108
24. Kudu Antelope Spiral	118
25. Graph of Stuttgart Tests	119
26. Water Vortex	126
27. Walter Schauburger	130
28. Pythagoras-Kepler School	132
29. Virbela Flow Forms	135
30. Apparatus for Oxegeating Water	136

31	Accelerators for Nuclear Fusion	137
32	Nebula Spiral	138
33	A Cycloid Curve	151
34	Schauberger's adapted Cycloidal Curve	151
35	Hyperbolic Spiral	152

# FOREWORD

Viktor Schauberger's early appreciation of the intimate relationship between water and forest, and their dual influence upon water resource management, the landscape's health within particular precipitation areas - is undoubtedly correct. His perception of these complex and important questions of human existence was rooted in his experiences within the natural environment of temperate Austria. Here the natural processes of destruction are slow in reaction to human environmental mistakes. In the tropics, where the landscape is more vulnerable, the rapid consequences of human forest clearance are more obvious and extensive. This often leads to the collapse of the drainage system, serious erosion, the destruction of productive land, the disappearance of vegetation and fauna, aridity, and even negative repercussions far out to sea, because of the river's unnatural sedimentary outflow reducing the light intensity of coastal waters, thus killing coral reefs which had provided living and breeding grounds for commercially important fish species living in the open sea.

Schauberger's theories about Europe are, in the tropics, thus verified in a convincing and shocking way. We, in the temperate regions will, in the long run, experience similar damage to our renewable natural resources if harmful ecological measures are allowed to continue within the productive environment.

Man has a propensity to plan and execute the exploitation of natural resources with sights set on immediate or the earliest possible returns, without regard to the long-term perspectives or ecological relationships. Modern forestry illustrates this. To survive, we shall have to think and plan within an ecosystematic dimension, which demands that we

respect and protect the ecological and genetic processes that are the basis for our existence; in other words, the inter-relationship between water-soil-vegetation and animals. Nature's plan is that they should coexist in perfect harmony.

Kai Curry-Lindahl,  
Senior Advisor, United Nations Environment Programme

# INTRODUCTION

Many people suggested that I write a book on Viktor Schauberger, the extraordinary natural scientist, inventor and philosopher. Already in the 1920s he forewarned us, in speeches and articles, of the environmental crisis in which we are now caught and from which we seem to have little hope of escaping. In his lifetime he met mostly resistance and scorn, but now interest in his life and work is increasing in many parts of the world. People are impressed by this powerful character who had such a tragic destiny, and by the audacious theories with which he wanted to transform the world.

Viktor Schauberger was not a learned man in the conventional scientific sense. He had, however, seen right into the depths of the workings of Nature, and his theories are based on his own understanding of Nature's life and functions. He was, of course, an outsider, an individualist; but history teaches us that, even within natural science, such people have frequently produced epoch-making discoveries, while in their own lifetimes being considered ignorant laymen by the learned world. Seldom achieving recognition themselves, following generations have often had cause to bless their work. It is possible that Viktor Schauberger will one day be included in this category of scientist

Until now there has existed no English language literature on Viktor Schauberger, except for some articles in that important but little known magazine *The Men of the Trees*. This book is a modest attempt to present some material on his life and work that I have collected since 1956, when I first became aware of him. I did not meet him personally but a long friendship with his son, Walter Schauberger, and with several of Viktor Schauberger's old friends and colleagues have made



me feel close to him and his work.

This is not a biography, and even less a detailed exposition of his theories. In the main I have allowed Schauberger himself and his close associates to do the explaining, and have tried to restrict my own commentary as much as possible.

I am aware that the information for the basis of this book is fragile. Part of what he himself wrote was lost during his fateful trip to the United States, the trip that undoubtedly led indirectly to his death. For practical reasons I have not been able to use further special sources; so it is possible that there are omissions and possibly some mistakes in the text. On the whole, however, the story is true.

I have thought it unnecessary to quote all my sources in the text. For those interested, the main sources are listed at the end. I hope the reader will not be exasperated by complex wording that appears, sometimes without explanation, in the quotations. Viktor Schauberger's language is sometimes difficult to understand and to translate. He was often forced to use prevailing technical terms which he redefined in order to explain his theories, as the old definitions did not express what he wanted to say. Occasionally, he created new concepts which can be very difficult to understand. He was aware of the problems this could lead to, but he saw no alternative. The words of one of his colleagues, Professor Wilhelm Baiters comes to mind: 'How can it be easy to understand Father Schauberger's language - his work belongs to the future'.

This is not the place to discuss the validity of his theories. Up until now, only a small number of them have been able to be tested. He may have been wrong in some, and misunderstood other things he observed in Nature; but nevertheless, what remains clear is that, if his central theme is correct, then this embodies a revolutionary discovery of crucial importance. Viktor Schauberger's central theme was: 'Prevailing technology uses the wrong forms of motion. Our machines and processes channel such agents as air, water and other liquids and gases into the type of motion which Nature only uses to decompose and dissolve matter. Nature uses another form of motion for rebuilding. When our technology only uses the decomposing motion, it becomes a dead technology, a destructive one, dangerously affecting all of Nature.'

Instead, Viktor Schauberger wished to make practical use of nature's reconstituting principle of 'cycloid spiral motion'. In

this he succeeded in some way, though not in others. His description of what he experienced in Nature can sometimes sound like pure fantasy. However, it should be remembered that much of what Viktor Schauberger studied for so many years cannot now be seen, for the natural environment in which he lived is now no more. Nothing alters the fact that the phenomena he describes could have naturally occurred in the unspoiled surroundings of his younger days, and that they have now disappeared through the environmental destruction that has broken down Nature's interconnectedness. His attitudes towards economic development in the world may seem exaggerated. Those around him in the 1920s and 1930s often found cause to be amused by his prophecies of doom; for example, that a botde of water would soon become more expensive than a botde of wine. Now, fifty years later, both this and other of his prophecies have become a reality in many parts of the world.

Viktor Schauberger can be criticized in many ways; but however his theories are regarded, it would be difficult to deny that he was a great friend of Nature and a man with original, grandiose and often revolutionary ideas. Many have been moved by his ideas about Nature and his philosophies of life, and would agree with Wilhelm Baiters: 'You may have lived a calm and contented life- but from the moment you come face to face with the ideas of Viktor Schauberger, you will never again have peace in your soul'.

I trust that this book, despite its incompleteness, imparts something of the gripping and inspiring personality and ideas of Viktor Schauberger. This meeting with such a passionate defender of water, forest and fertile soil may, it is hoped, give the reader a nagging anxiety born from a feeling of responsibility- a responsibility stemming from the awareness that the plundered and raped Mother Earth shall recover her health and dignity, the basis also for man's own health and dignity.

Finally, I wish to thank warmly all those who have in their different ways greatly helped in the writing of this book.

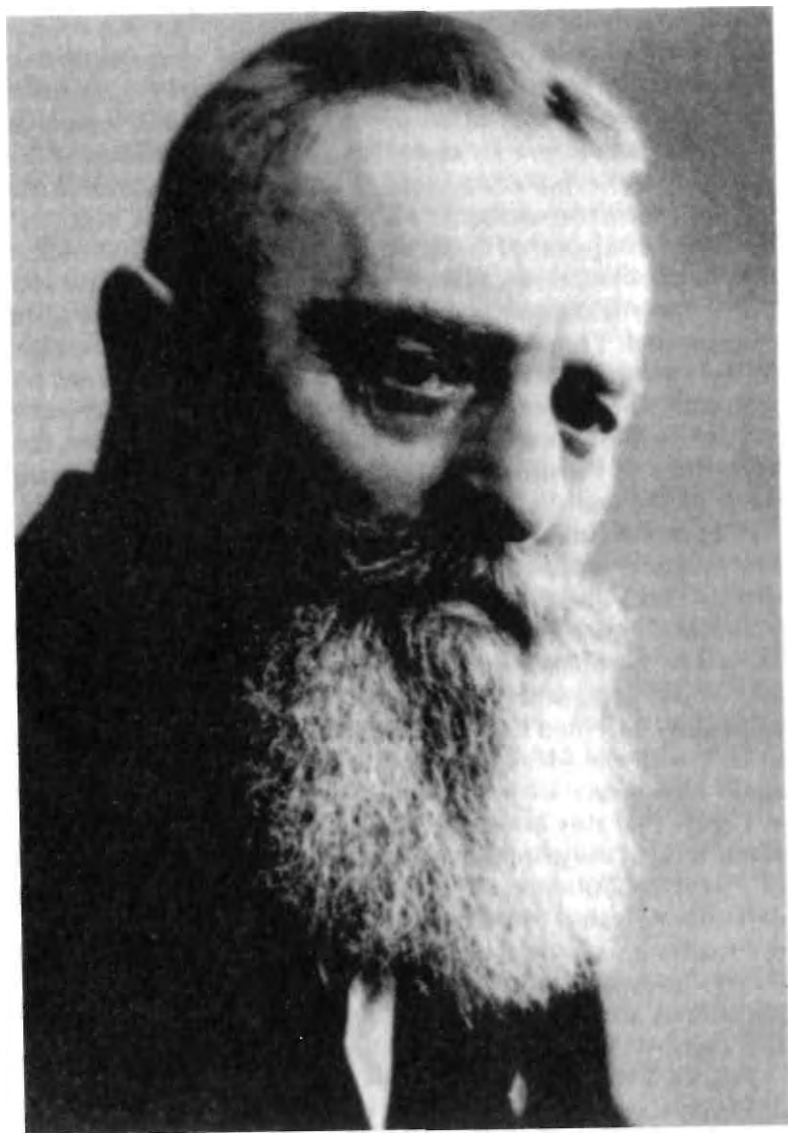

Victor Schauberg.

# 1

## WHO WAS VIKTOR SCHAUBERGER?

They call me deranged. The hope is that they are right. It is of no greater or lesser import for another fool to wander the earth. But if I am right and science is wrong- then may the Lord God have mercy on mankind.

Viktor Schauberger

### A Meeting

A scene in the German Reich Chancellery in Berlin one day in 1934. Hitler, reclining in his chair, fixes his unerring gaze on the man sitting opposite him across the massive desk. There is another person in the room - ministerial director Wiluhn, a powerful man, but now just a bystander. The one who dominates the scene is not even Hitler himself, but the man opposite him. This is a tall, powerful man of fifty years old, with a lighdy grey flecked beard, hooked nose and steady eyes - a man known in wide circles in Austria and neighbouring countries, and a man about whom there have been many controversies; a man with many enemies, but also many admirers. It is the legendary 'water magician' from Linz on the Danube - Viktor Schauberger.

Hider has requested his presence. He now directed a question to him: 'You are involved with a lot of things that interest me. But now you have come up with the curious idea of defining our technology as the greatest ever deceiver of mankind?'

Schauberger: 'Herr Reich Chancellor, do you really want to hear the truth?'

Hitler (surprised): 'Yes, of course, say what you wish.'

Schauberger: 'Herr Reich Chancellor, present-day science is following a wrong and dangerous path. First and foremost it concerns the treatment of water - the principal agent of life. The existing methods of water control, power stations and forestry are ruining water - the earth's blood. It becomes diseased, and so affects all its surroundings. Instead of progress, the future promises catastrophe. With your four-year plan, and the technological methods employed, you are demolishing Germany, instead of building her up. In this way, Germany will sink within ten years ...' But let us not anticipate.

### A Son of Water and Forests

Viktor Schauburger came from ancient Bavarian aristocracy who had lost their privileges and family residence, Schauburg, around 1230, after a feud with the powerful prelate, the Bishop of Passau. Around 1650, one Stephan Schauburger moved to Austria and settled down by Lake Plockenstein at the foot of the Dreisesselberg. He started a branch of the family whose members almost exclusively interested themselves in the husbandry of the forests and their wild life. In time their motto became 'Fidus in silvis silentibus' (Faithful to the quiet forests), and the family crest displayed a tree trunk garlanded with wild roses.

One of Stephan's descendants became the last leader of the hunt at Bad Ischl during the time of Franz Joseph. At the end of the nineteenth century, one of his brothers was master woodsman in Holzschlag, beside Lake Plockenstein. He had nine children, the fifth child being Viktor, born on 30 June, 1885.

Viktor was a true 'son of the forest', both from his heritage and his environment. There was never any doubt that he would follow in his father's footsteps. He wrote once, 'From my earliest childhood it was my greatest ambition to become a forest warden like my father, grandfather, great-grandfather and his father before him'.

Early on the boy showed great interest in everything to do with Nature. He could roam around the whole day alone in almost virgin forest (compared to today) around Lake Plockenstein, studying animal and plant life, or following the numerous wild mountain streams. He soon learned a lot not to be found

in books about the life of the forest and about water from his father and elder relations. He says of them: 'They relied upon what they saw with their own eyes and what they felt intuitively. Above all, they recognized the inner healing power of water, and understood that water, directed through irrigation canals at night can yield a significantly greater harvest than that of the neighbouring meadows and fields.<sup>34</sup> Their chief interest, however, lay in the care of the forest and the wild regions.'

His mother was also close to Nature, and he related how she often told him: 'If occasionally life is really hard, and you don't know where to turn, go to a stream and listen to its music. Then everything will be alright again.'

Viktor's father wanted his son to be academically trained as an arboriculturist, but this path had little interest for him. He soon broke off his studies, and began instead at the practical forest school, from which he duly graduated with the state forest warden's exam.

### The First Discoveries

His apprenticeship began under an older forest warden, and he has lyrically described how happy he felt as his dream was beginning to be realized. After the end of the First World War, he was given his own district, and, though remote, it had many advantages. He was employed by Prince Adolf Schaumburg-Lippe, who gave him responsibility over 21,000 hectares of almost untouched forest in Bernerau in Steyerling.

And so Schauberger's real period of learning started. In this large wilderness area, almost untouched by human hand because of its remoteness, he was provided with the opportunity of studying how Nature works when left undisturbed. There were many fine species of trees in this area that have since disappeared, a wealth of wildlife, and in the many fine streams a profusion of salmon, trout and other fish.

What Schauberger was able to study in this wilderness was often in sharp contrast to what was taught in academic forestry studies and it complemented the more traditional knowledge that he had absorbed at home.

Water was his consuming interest. He set out to discover its laws and characteristics and the connection between its temperature and its motion. He noticed how water running

from a mountain spring was at its greatest density, the so-called 'anomaly point' of  $+4^{\circ}\text{C}$ , and apparently at its highest quality. Salmon and trout, during spawning, drive themselves towards these sources, and he found the richest and most beautiful vegetation in these spots. During this early period as a forest warden, he experienced something that was to influence his understanding of water for the rest of his life. In the company of some old hunters, he had visited a remote district up in the mountains. Here there was a spring that had earlier been covered by a stone hut. This had subsequently been pulled down to expose the spring to light and sun. After a while, the spring had dried up, which surprised those who knew of it, as it had never done so before. Explanations for this were considered, and someone suggested rebuilding the stone structure. This was done, and after a while the spring returned.

It was now quite clear to Schauburger that water responded to forest and shade, and later he was supplied with much more evidence to confirm his theory. He began to perceive water as 'the earth's blood', and guessed that it must be allowed to flow along natural courses, if it was not to be spoiled. An untouched water course is shaped by winding curves and shaded banks covered with trees and bushes, not by accident. The water wants to flow in this way, and builds up these shaded banks to protect itself from direct sunlight'.

He meant that low temperature and natural flow was the condition necessary for water to preserve its supportive and carrying strength. He had seen how water could carry the greatest load on cold, clear nights, and he made early practical use of this observation. As a result of the war, the town of Linz suffered a serious shortage of fuel. This was during the winter of 1918. Up on the neighbouring Priel-Gebirge hills a lot of timber lay felled by fierce storms, but there were no draught animals- the war had taken those - and no large watercourses on which to float down the logs. Though Schauburger was merely a junior forest warden he felt confident enough to suggest to the town's magistrate that he be allowed to try to solve the fuel problem. The magistrate agreed.

In the district there flowed a stream thought unsuitable by the forestry experts for floating logs, but which Schauburger now decided to use. It was small and ran through narrow gorges, as he describes:

From my observations I noted how an increased water level resulting from a thaw builds up mud banks, which are then partially dispersed during clear cool nights when the water temperature drops. I then waited for an increase in the strength of the water current. This takes place in the early hours of the morning, when it is coolest, and particularly during full moon, in spite of the fact that the actual volume of the water is then apparently less, because of its contraction through cooling. I arranged for the timber to enter the water at the right moment, and in one single night 1600 cubic metres of timber were all brought down to a temporarily constructed pond in the valley.

He also became very interested in the behaviour of trout and salmon in the mountain streams. The large mountain trout could lie motionless for any amount of time in the strongest current. They made the odd movement with fin and tail, but otherwise appeared anchored in the rushing flow. If alarmed, on the other hand, they darted at lightning speed against the current instead of allowing themselves to be carried downstream by it, which would seem to be more natural.

Schauburger could find no explanation for the trout's behaviour in existing literature. However, he knew a mountain stream was colder near its source and became warmer farther from the source. Could this have some connection with the trout's struggle to escape against the current? He undertook several experiments to investigate this. As his observation point he chose a stretch of strong rapids along a stream where a large trout liked to lie. He had his woodsmen to warm up about one hundred litres of water and pour this in 500 metres upstream at a given signal. The stream was large, with a flow volume of several cubic metres of water per second. The meagre 100 litres of heated water did not noticeably warm up the stream. However, soon after the warm water was added, the trout - which until then had remained motionless - became greatly agitated. It flexed its tail, and was only with considerable effort able to maintain its position with vigorous movement of its fins. Soon its efforts were to no avail, and it was swept downstream, out of sight only much later to return to its old position. This convinced Schauburger that his theory was correct that there was indeed a connection between the



water's temperature and the trout's behaviour.

Schauberger also studied the trout's ability to jump up high waterfalls with little apparent effort. Within this phenomenon he saw evidence for his theory that the trout exploited some hitherto unknown source of energy within the water. He can himself describe such an observation:

It was spawning time one early spring moonlight night I was sitting beside a waterfall waiting to catch a dangerous fish poacher. What then occurred took place so quickly that I was hardly able to comprehend. In the moonlight falling directly onto the crystal clear water, every movement of the fish, garnered in large numbers, could be observed. Suddenly the trout dispersed, due to the appearance of a particularly large fish which swam up from below to confront the waterfall. It seemed as if it wished to disturb me other trout and danced in great twisting movements in the undulating water, as it swam quickly to and fro. Then, as suddenly, the large trout disappeared in the jet of the waterfall which glistened like falling metal. I saw it fleetingly under a conically-shaped stream of water, dancing in a wild spinning movement the reason for which was at first not clear to me. It then came out of this spinning movement and floated motionlessly upwards. On reaching the lower curve of the waterfall, it tumbled over and with a strong push reached behind the upper curve of the waterfall. There, in the fast-flowing water, with a vigorous tail movement it disappeared. Deep in thought I filled my pipe, and as I wended my way homewards, smoked it to the end. I often subsequently saw the same sequence of play of a trout jumping a high waterfall. After decades of similar observations, like rows of pearls on a chain, I should be able to come to some conclusion. But no scientist has been able to explain this phenomenon to me.

Schauberger, in another connection, suggests that a natural watercourse allowing natural motion, builds up an energy that flows in the opposite direction to the water. It is this energy that is used by the trout. In a suitably formed waterfall this energy flow can be distinguished as a channel of light within the streaming water. The trout seeks out this energy flow, and is sucked upwards as if in a whirlwind.

It was not only the trout, however, that he saw move in such an unusual way in these undisturbed waters. On a clear late winter night, in brilliant moonlight, he stood by a mountain pool formed within a rushing stream. The water in the pool was several metres deep, but so clear that he could easily see the bottom. Here lay stones, some as large as a man's head. As he stood studying these, he was surprised to see that a few of the stones were moving here and there, colliding with each other as if pulled together, only to be forced apart as if electrically charged. He explains:

I did not trust my generally observant eyes any more, when suddenly an almost head-size stone began to move in a circular path in the same way as a trout before leaping over a waterfall. The stone was egg-shaped.

In the next instance the stone was on the surface of the water, around which a circle of ice quickly formed. It appeared to float on the water surface, lit by the full moon.

Then a second, a third, followed by other stones in sequence went through the same movements. Eventually nearly all the stones of the same egg shape were on the surface. Other stones of irregular or angular shape remained below and did not move. At the time I naturally had no idea that it was a case of a synchronicity of events, leading to a unique form of movement. This movement overcomes the force of gravity and allows the stones of regular shape to come to the surface of the water.'

Schauberger says later that all the 'dancing stones' contained metals. It was such observations as these in his wilderness that caused him to ponder over the meaning of 'motion'.

He asked himself: 'What, in fact, is 'motion'?' Are there perhaps different types of motion? Might there possibly exist a form of motion as yet unknown to science? Out of his ponderings and observations there slowly grew a theory of the different forms of motion. He dearly wanted to put forward this theory, to discuss it with technical experts and scientists, but how was he to show that he had discovered something new?

## Log Flumes That Were Technological Mysteries

Prince Adolf von Schaumburg-Lippe had problems. War and inflation, post-war crises and, not least, a young and financially demanding wife, forced the ageing prince to investigate all possibilities of propping up his ever diminishing treasury. He had fully worked his other forest domains, and now there remained Schauburger's own district, where the Prince often wandered, complaining of his bad luck. For here lay large stands of mature timber, so ill-placed for transportation, that the costs of moving it would eat up all the profits.

Eventually Prince Adolf announced a competition for the best solution to this problem, which would release his frozen assets in the Bernerau region.

Suggestions flowed in from forest engineers, hydrologists and other experts, but none of them caught the Prince's eye. There was one suggestion that he never even saw - the competition committee sifted it out at the preliminary stage. A junior forest warden had had the cheek to compete with experts and, even worse, had presented an idea which was complete fantasy - a bad joke. They had returned it to him with a stiff reprimand for not taking the competition seriously - and that presumably closed the issue.

But fate had decided otherwise. After an unsuccessful competition Prince Adolf was still seeking large sums of money, particularly in view of the young princess's approaching annual visit to Monte Carlo. The Princess herself came to Schauburger's district to hunt deer, accompanied by a young forest warden. During the hunt she confided in Schauburger that the Prince must soon leave his estate as he was bankrupt. The conversation turned to Schauburger's entry to the competition, which had so angered the committee. He presented the plan to the Princess, who asked him how much could be saved in transport costs. Schauburger answered that if the costs up until now had been 12 schillings per cubic metre transported to the sawmill, the costs with this method would lower this to one schilling plus installation costs for construction.

The Princess succeeded in persuading her husband to try out Schauburger's idea, but the construction had to be built with the latter's own funds, on the understanding that if these lived up to expectation, the Prince would reimburse him. After considerable trouble Schauburger managed to find a

businessman to back him and the building commenced.

Schauberger's ideas had already been thrown out at the planning stage by all the experts on timber flotation, and criticism increased as the building proceeded. No one had ever seen such a construction. Schauburger built a wooden chute, fifty kilometres long, which in itself might have been acceptable, but this particular chute had an idiotic shape; it was not straight, but zigzagged alongside valley sides and ravines, instead of following the shortest route. Finally, and most crazy of all, this apparently dumb-witted forester meant to let out water from the chute here and there, and then replenish with fresh water from streams and water courses along the route. He must fill up with cold water, he said, otherwise the larger logs would not float in the chute. Cold water! Who had ever heard such nonsense! Water is water- but he would presumably discover this. Anyone could predict the result. Nothing could float in such a chute. But these malicious prophecies were unfulfilled, as Schauburger describes.

After about four months the construction was complete. The massive timbers lay ready in place. One day I conducted a simple experiment A log of average weight was fed into the trough. It floated down for about 100 metres and then suddenly grounded on the bottom of the trough, causing the water behind the log to rise and eventually to flow over the sides of the trough. I saw the scornful looks on the faces of the workers. I immediately recognized that I had miscalculated and felt disconcerted. The log was removed from the trough. My diagnosis was too little water and too sharp a fall. I was helpless. My first act was to send my fellow workers home so I might consider the problem quietly.

The curves of the trough were correct On that score there was no doubt What was wrong? Slowly I walked alongside the trough and came to the trap and sorting dams, to which was connected a further length of trough. The dams were full. I sat on a rock above the water in the warm sun.

Suddenly I felt something moving underneath my leather trousers. In springing up I saw a snake in a coiled position. I slung the snake away and it fell into the dam where it swam quickly to the far side and tried to get onto dry land. It was unsuccessful because the bank was too steep. It then swam

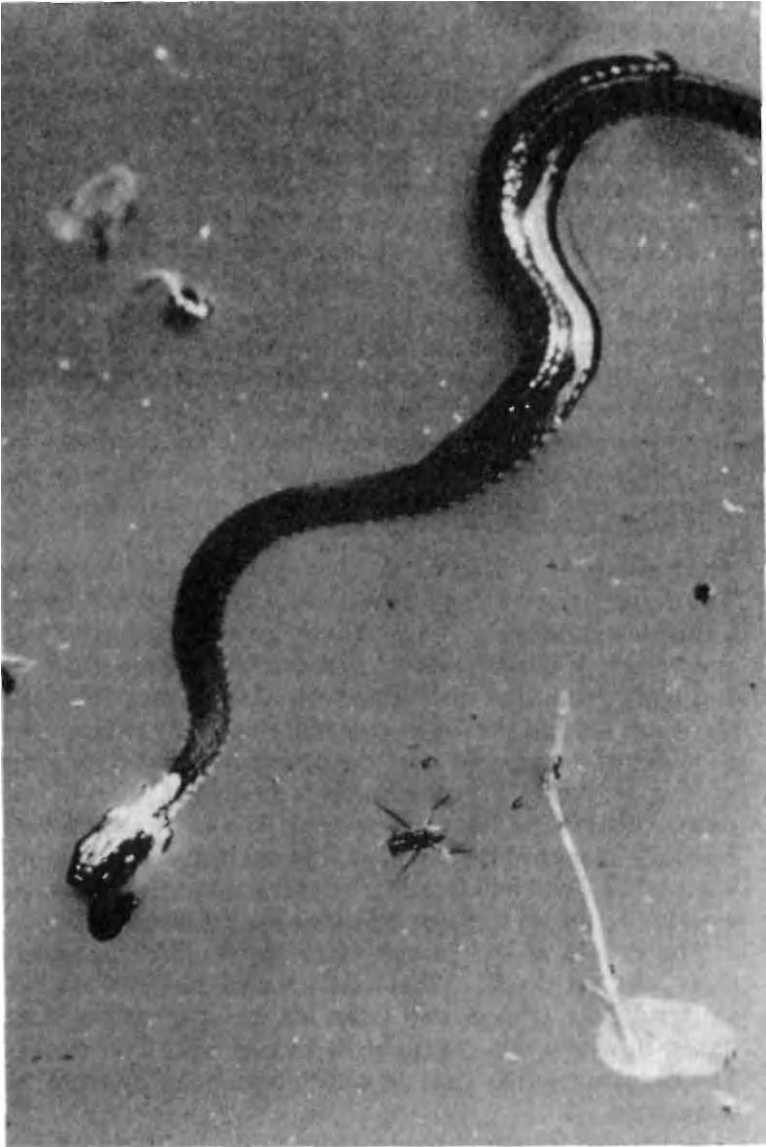

Swimming Grass Snake. The shape of its body, the movement and the wave-form all merge into one.

'Photograph W. Rohdich'

hither and thither seeking an easier way to land. I observed its movements and wondered how the snake could swim as swift as an arrow without fins. Looking through my binoculars I noted the peculiar twisting movement of its body under the crystal clear water. At last the snake managed to reach the opposite bank. For some time I stood still and in my mind replayed the movements of the snake — a combination of vertical and horizontal curves. In a flash I clearly understood the process.

The snake's movement through the water had given Schauberger the solution to the problem with the chute. He sent his workers to the sawmill to fetch some lengths of timber. The sound of hammers could be heard throughout the night as the lengths were nailed down within the curves of the chute to agitate the water into a snake-like motion. There was little time, as the opening ceremony was scheduled for the following day. Schauberger popped into his lodgings after midnight where he found a letter from the head forester telling him that at 10.00 am. the next morning the Prince and Princess, the chief for timber transportation, and other dignitaries were to attend the practical demonstration. Although work on the alterations continued throughout the night, he was unable to finish in time for a test run. It was left to hope that everything would function properly. Schauberger continues the story:

I went to the location of the dam inflow and waited until my people came, who were then followed by the Prince and Princess and also my bitterest opponents, experts and technicians. I greeted the royal couple and the head forester but did not so much as give a glance to the others. The Princess looked at me with an anxious expression, while the 'forstmeister' responsible for the floating logs stood leaning on a post, smiling in a superior way.

I opened the dam lock, behind which my workers began collecting the smaller sized logs in the water. Somehow a heavier log about 90cm thick entered with the rest unnoticed. 'No, no', shouted the old log master, 'We cannot have that heavy log amongst the others.' I gave a quick wave, while the unwanted log slowly floated almost out of the water towards the outflow. It soon caused a blockage resulting in a rise in the water level. No one spoke a word. All stared at the log

riding high in the water. In the next moment the water in the trough must overflow.

Then suddenly a gurgling noise was heard. The heavy log swung somewhat towards the right, then to the left, twisting like a snake, the head high out of the water as it floated away as quick as an arrow. After a few seconds the log negotiated the first elegant curve and was gone.

Success was complete. In his appreciation the Prince made Schauberger the head warden for the whole of his extensive forest and hunting territories.<sup>35</sup> Experts came from all over Europe to study the construction. The word spread like a forest fire throughout the forestry world about this extraordinary woodsman, and soon spread also to the government in Vienna

#### Schauberger Becomes the State's Consultant for Timber Flotation<sup>36</sup>

Soon there came a request from Federal Minister Buchinger to fill the position of State Consultant for Timber Flotation Installations. Schauberger accepted the offer and was given a contract with a salary which was double that of an academic working within the same field. Furthermore, payment was to be made in gold which was of special value in those inflationary times.

As a consultant, Schauberger travelled all over Austria for several years. He formed a close understanding with his nearest superior, minister Thaler, who had been a farmer in the Tyrol, but his relations with the forestry experts were more strained. The academics were particularly annoyed that this 'upstart' should have both the power to give directives on technical questions, which he could not possibly know much about, given his low level of education, and also command a salary to which he had no right as a non-academic. Bitterness naturally increased as their attempts to copy Schauberger's installations proved unsuccessful. They had tried without Schauberger's help to build a construction at Reichsraming similar to the one at Steyerling, but though it was copied in detail, the logs nevertheless remained lying on the bottom of the chute. Pride had to be swallowed and Schauberger was called in to partially rebuild it, after which it worked perfectly.

Under his supervision other constructions were built in Taschlschlucht and Murztal, amongst other places.

Schauberger's superior, the minister, was satisfied, but not those jealous of him. Finally they had had enough and gathered at a Congress for forestry experts in Salzburg, from where they issued a protest to Parliament about Schauberger's position, raising the issue about the Republic's accepted pay scales. Buchinger was caught in the crossfire and called Schauberger in to tell him that as his salary was excessive it could not continue to be paid. At the same time he said that the Government were pleased to retain his services though at half the former salary, the balance to be made up from the minister's so-called 'black funds'. This made Schauberger furious. He did not wish to have anything to do with such shady dealings. He had thought his country was governed by men, not old maids, and he tendered his resignation immediately.

#### With Senior Master Builder Steinhard

Schauberger did not have to remain unemployed. Steinhard, the chief of one of Austria's largest building contractors, was waiting almost outside the Chancellery doors. He had a new position to offer. Schauberger was to work for him building log flumes throughout Europe. He accepted Steinhard's offer and worked for him for several years.

Steinhard received a contract from the government for a large installation at Neuberg. This was built in 1928, and the contract stipulated that during the first hour of flotation the construction should be able to transport 1000 cubic metres of timber. If this was achieved Steinhard was to receive one million schillings from the government, but if unsuccessful then the whole structure was to be dismantled at Steinhard's expense.

The chute, in fact, managed 1400 cubic metres in the first hour and Steinhard received his million. In a festive ceremony the State took over the installation and Steinhard took the opportunity to present Schauberger with an inscribed gold watch, while praising him generously.<sup>37</sup> Described as a 'technical wonder' in a government memorandum, this log flume was still operating until 1951 when the forest became exhausted, and everything was then dismantled. The only remaining



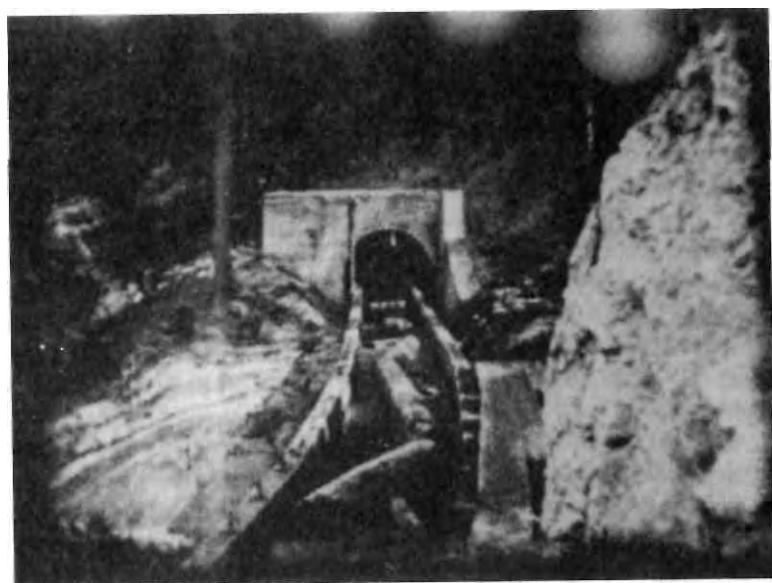



Logging Flumes in Neuburg.

record of this 'technical wonder' is a film, *Tragendes Wasser* that was commissioned by the Austrian Tourist Board around 1930. The film disappeared during World War II but in 1961 was traced to an archive in East Berlin, and copies were obtained for biotechnical organisations in West Germany and Sweden. Part of the original film had disappeared and what remained was worn and partly damaged, but this film still provides the best documentary evidence of these timber flotation structures that in their time so confounded expert opinion and engendered heated discussions, conflicts and investigations by learned authorities.

During the following years Schauberger, still in Steinhard's employment, built similar installations, not only in Austria but also in Yugoslavia, Turkey and other countries - always with success. Their association continued until 1934 when a contract was drawn up with the Czechoslovak Government for a water chute. Steinhard, however, tried to manipulate the contractual terms of payment and when this was discovered the agreement was annulled. Schauberger now came into conflict with Steinhard when criticizing his methods, and their paths separated. This marked the end of Schauberger's

building of log flumes. Much later he was, in fact, offered a contract by the German State but he was unable to begin building before World War II.

The time with Steinhard had been a period of considerable advancement for Schauberger, but at the same time he had continued the struggle against his old enemies within the academic world. Steinhard had many successful technicians and architects under him. They had observed the growth of Schauberger's influence with increasing bitterness, and constantly warned their superior that one day he would be ruined if he allowed this 'uneducated dilettante' to continue his absurd experiments. But Steinhard kept his faith in Schauberger even though on many occasions large amounts of money were at risk. He never had any reason to change his mind.

### The Principles and Construction of the Log Flumes

It would be appropriate at this point to identify some of the origins of Schauberger's inspiration.

I knew that my father transported hundreds of thousands of cubic metres of beechwood over long distances, never, however, during the day, but at nights and generally when the moon shone. The reason for doing it this way, as my father often explained, was because water exposed to the sun's rays is tired and lazy and therefore curls up and sleeps. At night, however, and especially in moonlight, the water becomes fresh and lively and is able to support the logs of beech and silver fir, which are in fact heavier than water.

Schauberger's family had even earlier traditions of timber flotation that he could call on.

Sometimes the high water in the streams would damage the contraptions built in this forest region for floating down timber. These constructions forced the water to flow in quite strange serpent-like spirals, either clockwise or anti-clockwise. The term 'cycloid spiral space-curve motion'<sup>2</sup> was naturally unknown to these foresters, but they used this effect so cleverly in the construction of the wood and water troughs that a curious interaction sometimes took place

between the timber and the water mass in response to the curves in the troughs. This had the effect that some of the logs, as if to challenge the laws of gravity, would even temporarily float upstream.

Schauberger had already made use of these background ideas at Prielgebirge, but they were nevertheless a long way from his sophisticated later logging flumes.

He explains another of the impulses that stimulated him to think about the building of these flumes:

Those who have witnessed the awful cruelty to which beasts of burden are subjected in the exhausting process of transporting timber through mountain regions might perhaps understand why I have worked so hard to find an alternative to bringing timber from the higher regions without the use of horses. My proposals to transport timber by water were always rejected because these methods usually caused more damage to the timber than the cost of providing roads and forest ways. Moreover, Archimedes Law was always quoted, i.e. the large beech logs were heavier than water and therefore would not float. Clearly my ideas were considered to be purely Utopian.

Timber floating in these mountain regions was normally a very rough and ready business. There was a great difference in height between the forests up in the mountains and the valley floors where the timber was to be transported. Water drainage, usually in the form of mountain streams, flowed through narrow gorges and ravines, often without enough water volume to float the heavy logs. Thus, intermittent small lakes were formed by damming, into which the logs were rolled. Then the dam gates were opened to allow the reservoir of water and timber to rush forth down to the next dammed lake where the sequence was repeated. The mass of rushing water hurled the logs hither and thither, splintering against stones and rocky banks. The water courses were also damaged, and it was generally held that this method of transportation was both uneconomical and damaging to the environment. However, to build conventional chutes was considered unthinkable as they would require large supplies of water, if heavy logs were to be moved long distances.

When Schauberger, to prove his theories about water, decided to build a new type of flume, his main problem was to achieve the greatest carrying potential from the smallest amount of water. His own hydrological studies confirmed his father's inspiration: the solution to the problem must lie in giving water the right temperature and motion, but to realize this practically was no simple task. He took out several patents for timber flotation structures, showing that he was wrestling with a whole series of problems in this area

Finally he decided upon the following construction. A wooden chute was built to the same sectional proportion as that of the widest part of an egg. The dimensions were fairly small, perhaps 1.5 metres wide, 0.9 metres high. The largest logs snugly filled the width (such giant trees still existed at that time) so that there was little room left for the water. At regular intervals he built 'mixing' stations where fresh water was introduced, carefully monitoring the temperature, while the existing water in the chute which had had time to warm up was syphoned off. Using ingenious valves, which he designed himself, he could select the water temperature he required in the chute. The chute then followed the meanderings of the stream and river courses - even though this was a longer route — and so the appropriate water motion was obtained. This depended on the right temperature, the correct profile of the chute, and finally a meandering route. Or as Schauberger said: 'Water in its natural state shows us how it wishes to flow, so we should follow its wishes.'

Here he follows the principle that would be a guiding light throughout his life: 'Kapieren und Kopieren'; in other words, 'first understand Nature, then copy it' He said Nature is our foremost teacher. The task of technology is not to correct Nature, but to imitate it.

All such talk continued to be so much nonsense to the hydrologists and technologists who knew that the short way was the best and the cheapest Schauberger's assertion that even a temperature difference of  $1/10^{\circ}\text{C}$  had a significant effect on the behaviour of water was ridiculed. Many agreed with the famous hydrologist Professor Shaffernak: 'This Schauberger talks nonsense. Everyone knows that only large differences in temperature are important to water.' When Schauberger replied that a variation of  $1/10^{\circ}\text{C}$  in the body temperature of a person can determine health or sickness, it reinforced the



Water Disturbance Pattern. A thin brush has been drawn in a straight line through a shallow tray of glycerine treated water, whose surface has been dusted with powder. (Schwenk method, photo by A. J. Wilkes).

attitude that he was mad, drawing parallels between blood and water, indeed!

Schauberger and his theories had generated little interest amongst the experts, and it was left to his log flumes to stand as incomprehensible, mocking reminders that he, nevertheless, must know something that had escaped the 'wise and learned'. One was forced to witness how Archimedes' Law was not applicable, how logs with higher specific weight than water, yes, even stones, floated like cork in these chutes.

The dilemma had to be resolved. A State Commission was formed to investigate thoroughly the flotation installation in Neuberg. The internationally recognized hydrologist, Professor Forcheimer from Vienna, was to head the Commission.

### Professor Forcheimer's New Experiences

Forcheimer launched himself into the project with his customary zeal. He studied the chute, analysed its profile and curve mathematically, looked at charts of water movement and temperature - in short, he directed all his considerable knowledge as an accepted expert on water and waterworks to the problem, but without success. It was impossible for him to explain why the mysterious chute worked as it did.

He then changed tactics and began instead to shadow Schauberger, following him everywhere while he was building and experimenting, ceaselessly questioning him. At first he merely obtained short and crusty answers, and often in terms that Forcheimer did not begin to understand. Strangely, he was not discouraged but continued his close observation.

After a while Schauberger discovered that Forcheimer was different to the scientists he had met earlier. He was not derisive and superior but became more and more worried at meeting something he did not understand. Schauberger discovered, almost against his wishes, that he was developing an interest in this learned man, and there grew a deep friendship between the two. So they wandered in the woods and dells and Schauberger showed him the natural phenomena that he had studied for so long. There is an eye-witness account of what took place on one of the first of these excursions. The two men stood beside a mountain stream, deep in discussion. Suddenly Schauberger said:

'Can the Professor tell me where the water is coldest, before or after it has flowed around that stone?' - and he pointed to a stone out in the stream, which had been worn away to a particular shape. 'There is not the slightest doubt that the water is colder before it has passed the stone', answered Forcheimer, and then he began to explain how the friction against the stone increased the water temperature. 'Completely wrong', replied Schauberger. 'The water is colder below (i.e. downstream from) the stone.'

A forceful debate ensued and Forcheimer drew up flow charts and temperature diagrams in the sand on the stream bank to emphasize that he was right. After a while Schauberger said:

'Would it not be simpler if we measured the temperature of the water to see who is right?'

He had a thermometer with him and strode into the water in his leather breeches. When he had taken the temperature he accounced triumphantly to the impatient Professor that the water below the stone was  $2/10^{\circ}\text{C}$  colder than above. Forcheimer lost his patience and exclaimed:

'Impossible! You must have measured incorrectly! Let me take the thermometer so that I can read it myself!'

And with considerable difficulty he untied and took off his boots, turned up his elegant trousers and his red pantaloons, and carefully ventured out into the water - quite an effort for him as he was seventy-two years old at the time.

He grabbed the thermometer, took the readings and then fell silent; he forgot that he was standing barefoot in a cold stream. He then cried in a voice full of surprise: 'You are quite correct'. As he mulled over the matter he waded back to the beach and put on his shoes again.

From that day he was really convinced that this stubborn, irascible, eccentric investigator apparently dealt with facts, though it was difficult to follow his theories and his cryptic language.



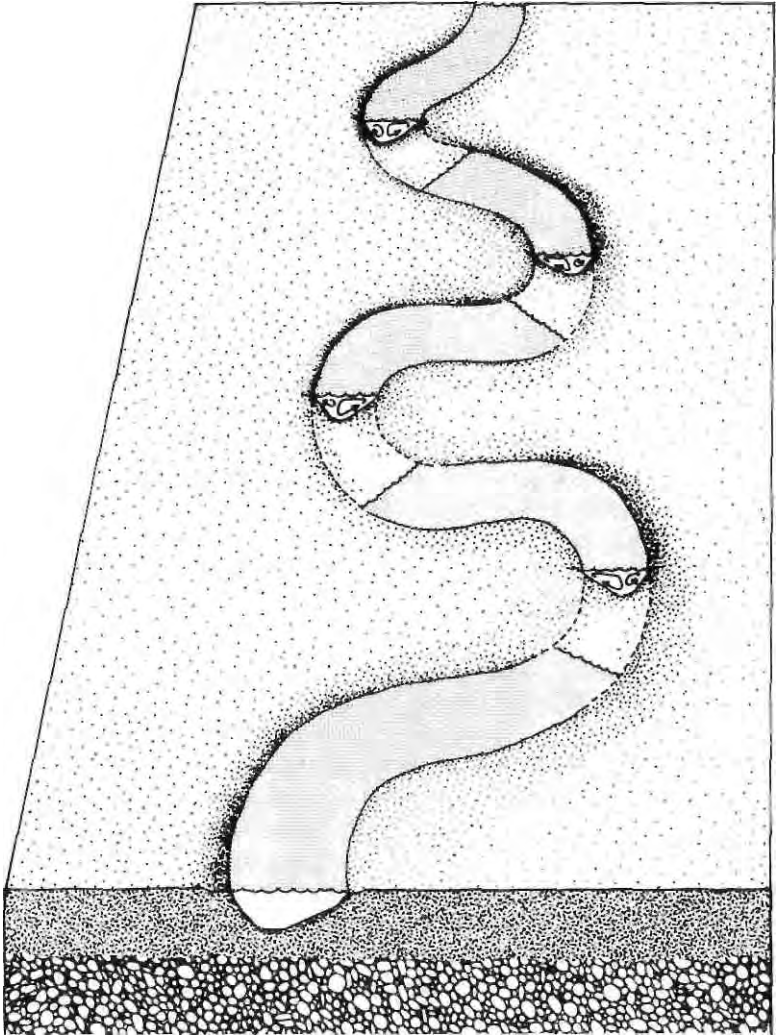

Natural River Profiles. A meandering river as it flows develops secondary currents at its bends. The smaller one at the steep bank becomes the larger one at the outside of the next bend.

## 2

# NEW TECHNIQUES OF WATER MANAGEMENT

### Denudation of Forests Destroys Watercourses

It was not only log flumes that captured Schauberger's imagination. The area of his interest was wide, but water continued to be his main cause. It was behind everything in forestry, farming or the management of energy. He became increasingly convinced that economic, social and political stability in Europe - and the whole world - would become dependent on a new attitude towards water, the forest and soil. Scientists must be made to realize that water was not something to be handled carelessly, like an inanimate object. Water was not merely H<sub>2</sub>O, but a living organism with its own laws commanding respect from mankind, if the consequences were not to be fatal. Because of his many opportunities for studying Nature's relationships in a relatively untouched environment, he was able - perhaps better than most - to observe the dangerous changes that occur when man disrupts the natural harmony. It frightened him to see what happened to springs and watercourses, to animal and plant life, when areas were deforested. This clearing of forested areas spread like a bush fire in Austria after the First World War. The country's economy was suffering and forests were the easiest source of revenue. No one thought of deforestation or in any other way to limit the damage that occurred as soon as the trees were felled. Precipitation, avalanches and earth slips soon carried away all the soil from the mountain regions and so forever hindered recultivation.

The changes after deforestation were first noticeable along the water courses. Schauberger had earlier studied springs and streams in detail and had seen how they never dried up,

how the stream channels were covered with moss which was not torn away even when the stream was in spate. He had also noticed how the water weeds could be pointing upstream, a phenomenon he understood to be associated with the water's energy. The more strongly these weed 'tails' pointed upstream, the better the temperature and flow characteristics of the watercourse. Such streams never destroyed their beds, or overflowed, even during heavy downpours.

All this changed when the forest was cut down. The streams reacted first. They became 'wild'. Weed and river bed vegetation was uprooted and carried away. The water could no longer keep its channel 'clean' but instead deposited gravel and sludge that filled up the watercourse and caused it to overflow. The water then attacked its own channels, eroding and breaking out of its banks and endangering surrounding areas, especially after heavy rain or thaw. Then the springs began to dry up. The water level sank over extensive areas around a deforested region. Finally the stream completely disappeared<sup>38</sup> - except after a sudden torrential downpour when it could become a raging torrent, threatening both buildings and their inhabitants. Gradually the whole hinterland around such a denuded area dried out.

There was great concern about the destruction of the watercourses. This gave rise to the water management technology that was applied to streams and lakes in Austria and parts of Southern Europe. Watercourses were enclosed by stone and concrete embankments to prevent the water breaking out of its channels, with the attendant catastrophic effects. This is a never-ending task; the walls and dykes have constantly to be maintained as the water is continually attempting to erode and undermine them. The costs of upkeep are enormous, bringing great profit to the stone and cement industries.

By the end of the 1920s Schauburger had already begun, in speeches and articles, to attack the decimation of forests and the existing techniques for controlling water. It is fair, perhaps, to point out that he had contributed to this deforestation through his flotation chutes. He had, though perhaps naively, sought to restrict timber felling by reducing transport costs and thereby increasing net income. At the same time as building the chutes he constantly emphasized the need to harvest only the 'interest' of the forests' capital, and not to clear them totally. But these, of course, remained unheeded warn-

ings. The large timber companies that sprang up everywhere, with encouragement from the state, had only one goal; to transform trees into money as quickly as possible. This also occurred in Sweden during the forest clearance period, when many unexploited forests came under the axe. The techniques of forest clearance still used in Swedish forestry are presumably as negative in their results as the original clearances.

Schauberger saw that the catastrophe inherent in such deforestation was compounded by the hydrologists' attempts to control the wild watercourses: 'A water course', he said, 'should never be regulated from its banks, but instead from within, from the flowing content itself.'

He recommended that these attempts to wall in the water channels should be given up, and if a natural river environment were recreated, the rivers would control themselves.

Schauberger had quite early considered how to tackle these problems. In 1929 he took out a patent on 'inserted installations for controlling wild streams and flood regulation'. According to the text of the patent, 'The installation brakes the water's velocity in such a way that the gravel and sludge borne within it, cannot cause dangerous disturbance. Furthermore by the positioning of these braking barriers at suitable intervals the water's motion is influenced in such away that the theoretical axis of flow will be redirected towards the middle of the channel stream'.<sup>3</sup> He took out another patent in 1930 for a complementary development that concerned 'the construction and arrangement of regulators of outlet water from holding dams, and the strengthening of the dam structures'. The introduction to the text of this patent states that an important detail had been omitted in earlier attempts at directing watercourses, namely the water's temperature, its relationship to the surrounding ground and air temperature and also the temperature differences within the water flow. Nor has there been an appreciation of the influence of the water's temperature on its motion. If, as has been the practice up until now, a watercourse is divided up into linear sections, and control gates are used to let out either surface or bottom water, disturbances are created in the watercourse below the dams in the form of meandering and damage to banks. Instead the outlet water should be at such a temperature, through the mixing of warmer surface water and colder bottom water, that it is related to the existing air temperature. Then there is a

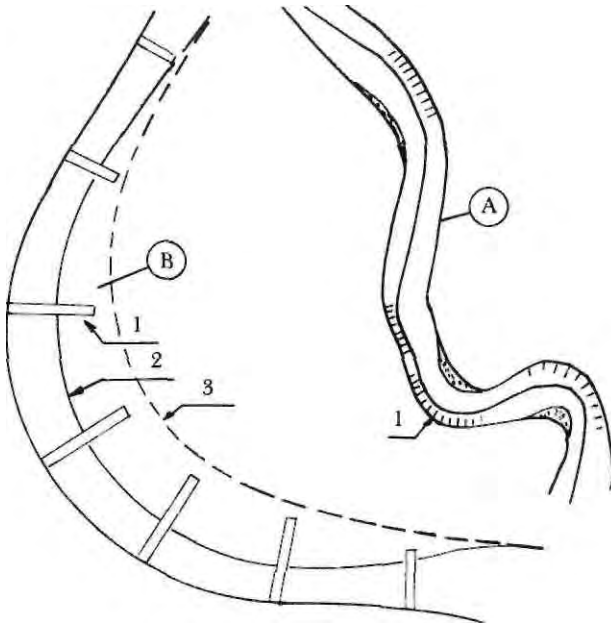

A scheme for flood control. (A) shows a watercourse to be regulated. A breaking barrier has been built into the river bed at (1). (B) shows how the axis of flow will be moved from (2) to (3) after the barrier has been working for some time.

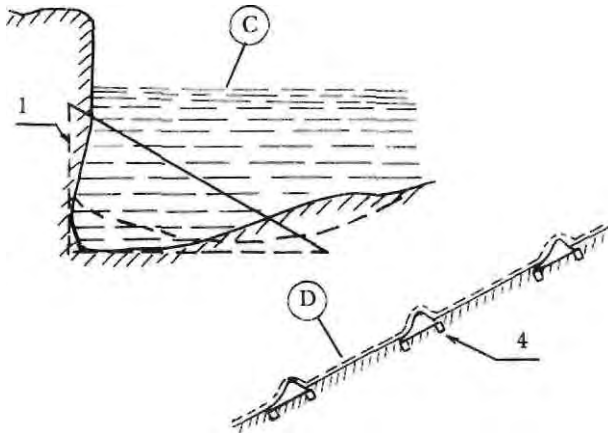

(C) shows details of braking element (D) shows another type of braking element (4) for mountain streams, to slow down the speed of flow, thereby reducing the amount of material carried away from the bed and banks. (Taken from Austrian patent 11 34 87.)

balanced watercourse that carries its suspended matter at an easy pace and does not attack the banks. This patented discovery now allowed for the automatic regulation of these conditions, largely through the use of air temperature regulated outlet valve.

In the 1930s Schauberger set out in a treatise all that he had come to understand about the mysterious laws that seemed to govern the behaviour of water, and the curious interrelationship of how it moves according to its temperature profile. He also discussed the importance of water to forestry, farming and the whole community. He saw the appalling effects of deforestation as the harmful consequences of unnatural water regulation, and made suggestions to solve these problems. It was due to Professor Forcheimer's strong interest in these theories that his work was published.

### A College Debate on Land Culture

Forcheimer's interest grew so strong that he asked Schauberger personally to expand his theories to a gathering of experts, and Forcheimer's presence at the meeting would ensure that these 'heretical ideas' would at least be received with some attention.

The academic board at the Agricultural College in Vienna was the forum chosen by Forcheimer. Schauberger was presented to the Rector and his staff who immediately annoyed him with their patronising and arrogant behaviour. The Rector spoke a few words of introduction and then asked Schauberger to 'teach us experts how to regulate water in a natural way so that there is no damage to the riverbeds and banks ...'. Schauberger answered that this could not be answered in a few words, as the Rector anticipated. Moreover the latter insisted that the core of Schauberger's methods should be expressed in a few phrases 'How, in simple terms, should we regulate our watercourses?'

Schauberger was now really irritated, and emphasizing each word he answered: 'Just as a wild boar passes water.'

The reaction to this was 'confusion, silence and wrinkled noses', but then the Rector in a condescending tone urged Schauberger to explain himself factually, choosing his words carefully. At that point Forcheimer got up and proclaimed that Schauberger's last remark not only hit the nail on the head but was also factually correct. He then strode to the blackboard

and proceeded to cover it with formulae, much to the Rector's displeasure. After that Forcheimer began to lecture. 'I did not understand a word he said', declared Schauberger, but the gathering, professors, technicians and even the Rector became more and more interested, and a discussion ensued that lasted for two hours. It was only interrupted because the Rector remembered that he had to attend another engagement. He bade Schauberger farewell in quite different tones and hoped soon to be able to continue the discussion.

When they met next morning Forcheimer asked Schauberger how he had come upon the analogy of the wild boar. Schauberger replied that he had merely remembered the phrase used by his father to explain to his workers how to arrange the 'brake curves' in streams with little water, to be able to carry out timber flotation. These brake curves introduced the water to a spiral motion around the axis of flow, that resembled the curve of urine made by a running wild boar. Forcheimer agreed that this must be the most perfect imaginable cycloid spiral curve, but to calculate it mathematically would pose great problems to existing science. Schauberger could well appreciate this as he recognized it as a movement that was found in all life's processes. When they had discussed this for some time the professor explained that he could only think in terms of formulae, and that Schauberger thought 'in a way no other person understood', and the two could not be brought together.

### Schauberger Gets a Treatise Published

Later on Forcheimer suggested that Schauberger should write about his theories in the periodical *Die Wasserwirtschaft*, but first they should go together to Brunn to meet Professors Schocklitz and Smorcek.

The visit to these two hydrologists who had, for their times, extensive laboratory facilities, did not yield a positive result. But Professor Smorcek, who was also the head of the Technical College in Brunn became very interested in Schauberger's ideas and suggested that they should meet Professor Schaffernak at the Technical College in Vienna. Forcheimer then claimed that this would be meaningless as Schaffernak could not even explain why the rivers Danube and Inn did not mix their waters when they met, but flowed parallel to each other

for a long stretch, within the same channel. Some time later, after Smorcek came to Vienna, the meeting with Schaffernak took place anyway. The result proved negative as Forcheimer had foreseen. It was only Forcheimer himself who learned to understand Schauburger more and more. In the last textbook he wrote, he described the 'cycloid brake curves' with Schauburger's theories, and when he died he was working on a new book on Schauburger's ideas about water. He said to Schauburger just before his death: 'I'm glad that I am already seventy-five years old. It can no longer hurt me that I took up your ideas without question. A time will come when you will be understood.'

Forcheimer had time before he died to carry out his promise to publish Schauburger's treatise on the subject. During 1930-31 this was serialized in *Die Wasserwirtschaft* (Hydrotechnology) in Vienna. Forcheimer himself wrote the introduction, stating 'The contents have captured my deepest interest through their new insights, which not only promise to stimulate productivity but also cut through all traditions of dam and waterwork technology ...' On another occasion Forcheimer said that 'the day will come when Schauburger's ideas ... will change the whole world'.

### Schauburger Offers to Regulate the Rhine

Few European rivers today give as clear a picture of the tragic consequences of deforestation and conventional water regulation as the Rhine. This mistreated and degenerated watercourse had at one time been a mighty river with such crystal clear water that the river bed could be seen to a depth of several metres. At night when the supporting power of the water was greatest, stones were carried down bumping and scraping each other, and discharged a glowing yellow light from the river bottom that gave rise to the folktales of dwarves who made wonderful jewellery in their smithies on the bottom of the Rhine. In the opera *Rhinegold* Richard Wagner uses this story as his theme.

Even this legendary river, however, was to meet a sad fate. This began with the timber cutting in the Swiss Alps in the region of its source. This disturbed the balance and the river began to silt up. Then in order to increase the velocity of the flow and to enable the river to clear away its path, bends and





The Rhine - a dying river.

meanders were straightened. The result of this was that more eroded material was carried even further away. In turn, more curves were straightened downstream, and the process was repeated. Once straightening had begun, there was no alternative but to keep on until there were no curves left and then the whole river began to silt up. The fundamental cause of this was the forest clearance, which destroyed the ecological balance. The forest's great storing and cooling effect was lost. The precipitation could no longer be stored up and instead all the water ran off at once, scouring everything in its path. The draining water heated rapidly and so soon deposited its burden of stones and gravel. The river bed was soon filled up again with consequent flooding. Water technicians then in their turn began to strengthen the river banks with walls of stone and concrete and to dredge the channel. To the joy of the dredging companies they now had constant employment since after each heavy downpour in the mountains the high water came rushing down the river to deposit its load which again had to be dredged up. The river banks also had to be constantly repaired.

In 1935 there was heavy flooding in the Rhinelands. New

and even more expensive preventive measures were planned to reinforce the banks and clear the channel. It was then that Schauberger reacted to the German authorities, sharply criticizing their intended measures through articles and letters, while at the same time explaining how the river should be regulated to look after itself:

To lower the level of the Rhine by 4 to 6 metres is simply a question of increasing the carrying capacity of the river. It involves regulating the water temperature, and would cost only a fraction of the amount required for the usual method of flood prevention. It is nonsensical to attempt dredging. One case of flooding is sufficient for the locks which have been dredged, to fill up again. One has only to think that each year the Rhine washes downstream about 100,000 cubic metres of mud and gravel. Equally every rise in the river bank causes an increase in the danger of a breakthrough, which is in fact unavoidable if there is flooding and the water is warm. I should be invited to make suggestions instead. For a small cost danger of flooding would be averted forever. I would guarantee you a successful system of regulation and I would not ask for payment until the bed of the Rhine had sunk some 2 metres.

No one paid any attention to Schauberger's offer. The traditional methods continued, as they still do, while the Rhine becomes more and more silted.

To regulate the Rhine Schauberger intended to use, among other things, his so-called energy bodies for implantation into the river bed. These would simply be suitably shaped 'flutes' that would direct the water into the motion that has been described above. He had experimented with these earlier.

When some years ago I secretly installed my energy bodies in the Steyrling stream, the water during a single night was so washed that hundreds of cubic metres of sand and grit were thrown up into the so-called sand trap to form a large heap, and the water level of the stream sank to the rock overnight.

Along the smoothly formed banks or specially shaped stones, the water flows faster and excavates material more than in places where only small quantities of water move

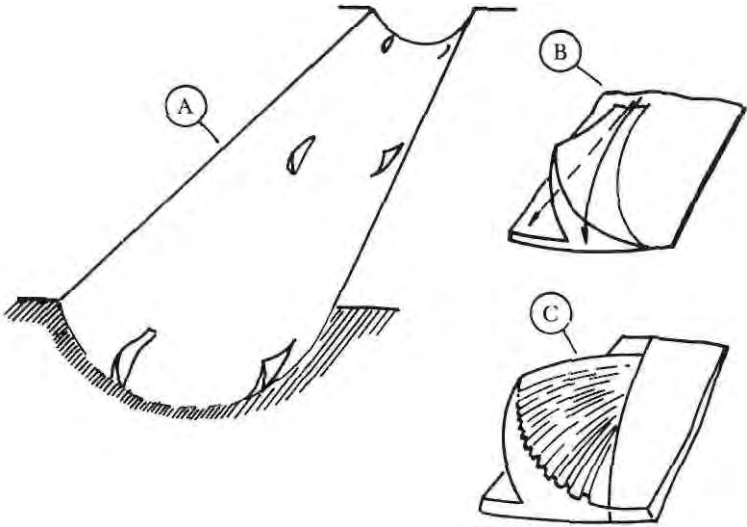

(A) shows a schematic diagram of a watercourse, in which the 'energy bodies' of type (B) have been systematically placed to enclose the theoretical flow channels. By way of these obliquely placed flutes, the water is propelled into a spiral motion in the middle of the flow channel (from Austrian patent 13 45 43).

against each other. This phenomenon can be used in controlling flow. If we regulate within reason the forces within the river by the introduction of impulses, we are able to obtain the scooping action in the middle of the river rather than near the banks, and in this way achieve a deepening of the water channel along the axis in the middle of the river. With the increased depth of water, the particles of grit and other material automatically move differently, as their velocity is slowed, and thus the river moves more freely.

In a properly regulated river, a capillary type action is formed purely mechanically through which the turbulent parts of the water spread outwards towards both banks and there divide into smaller masses; in the process they grind and crush what material is being transported, while the main part of the stream flows along relatively undisturbed,

the different layers of water within it internally charged with energy enabling it to carry the rough solid matter.

The flow of the main mass of water has the effect of selecting its load so that the coarse matter begins to drop away and is gradually drawn to the sides where the water is more turbulent, and where the mechanical process of breaking up into smaller fragments takes place. The lighter sand particles found in the main stream are unable to remain there because of their low specific weight and are quickly forced to the sides. Through this simple action the main axis of the water flow is prevented from silting up. What is quite clear is that a healthy river expands laterally and builds its own banks. Moreover the plant world thrives on the banks and protects the mother of all - the water.

The water's ability to carry out its function, even in the turbine room of a power station, depends on the condition of the spring water catchment areas and the drainage basin itself. If, for example, through deforestation, the landscape's normal equilibrium is disturbed, the water loses its strength, like a person who is running a temperature.<sup>5</sup> In his treatise in *Die Wasserwirtschaft* Schauberger describes the basis for natural water regulation and shows how both the landscape and any adaptation of a watercourse affects the quality and health of the water. He showed how the surrounding temperature and other factors, alter the profile of flow in a watercourse and the different motions within the water, the turbulent and laminar flow that have such an important effect on its 'metabolism'. He also showed in detail how with the construction of specific dams, the areas of land around the watercourses could be reclaimed in a positive and natural way.<sup>6</sup>

'Positive' and 'negative' temperature changes are an important factor within Schauberger's water theories. The former is water approaching +4°C. Within this temperature range the water's energy and its centripetal cycloid spiral motion is increased. It becomes healthy, alive, and new water is built up through what he called 'emulsion' when the oxygen is bound by the hydrogen. Within 'negative' temperature range the water, warmed to over 4°C, has a diminishing energy and biological quality. The hydrogen is then bound by the oxygen, which leads to the water's slow degeneration, its loss of carrying power, and encouragement of pathogenic bacteria.

### 3

## SCHAUBERGER'S TEACHINGS ON WATER

### Studies of Water

Water takes a central place in Schauberger's view of the world. It is the container of life and full of mystery.

Far back, in history, there is evidence that men who have attempted to solve the riddle of water have been bitterly attacked. Every attempt to explain the nature of water in old books has been demolished in later editions. In any case, maintaining the sense of mystery about water ensures the prosperity of the capital intensive economy, for financial interest thrives only on a defective economy. If the riddle surrounding the origins of water were solved, it would be possible to make as much pure water available as required at any location; in this way vast areas of desert would become fertile. As a consequence, the selling values of the produce would sink so low that there would be no more incentive to speculate, or to develop agricultural machinery. The concept of unrestricted production and cheap machine power is so revolutionary, that the way of life all over the world would experience a change. Maintaining the mystery of water, therefore, maintains the value of capital, so every attempt to come nearer to an explanation is attacked.

Even if Schauberger's claims to have discovered the key to water's mystery may seem inflated, his knowledge of water was certainly considerable. Above all it was built on many years of concentrated study of Nature; but from a number of his writings it is clear that he was not a stranger to theoretical hydrology either. He insisted that technicians and scientists

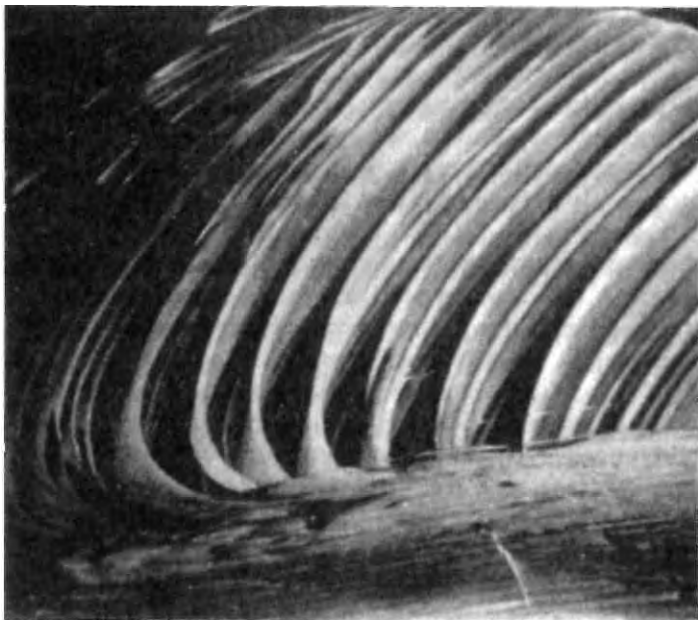

The two photographs above show motion within a water droplet. (Karl H. Henssel Verlag, Berlin).

who studied water in laboratories had hardly any chance of ever knowing anything meaningful about the reality and character of water. 'Water at research establishments concerned with probing its characteristics should never be so intensively analysed and measured. The 'water corpse' brought in for investigation can in no circumstances reveal the natural laws of water. It is only with natural free-flowing water that conclusions can be drawn and ideas formulated. The more profound laws are, however, hidden within the organism of the earth.'

'At least one now knows water is not always water', says Schauberger. Now it is known, for example, that there is 'heavy water with special qualities; but generally, as far as science is concerned, water is thought to be an organically dead chemical substance, with several different sequential forms, and with a cycle from the atmosphere to the sea. But the problem of water is not so simple; he explains:

Actually, the mysteries of water are similar to those of the blood in the human body. In Nature, normal functions are fulfilled by water just as blood provides many important functions for mankind.<sup>7</sup>

Schauberger also made use of history to aid him in his hunt for the key to water's mysteries. He carefully studied how people in earlier times had treated water.

The Romans made their springs effective by carefully placing a thick stone plate sideways at a particular height over the mouth of the spring. A hole was then cut into the plate, through which a pipe was inserted, which was made sufficiently tight so that no air could escape. This and similar methods of those times took more account, despite their simplicity, of the nature of water than modern methods, which generally disturb the immediate surroundings of the spring by the use of lime, cement and metal. This interrupts a symbiotic relationship between the spring and its close environment

In considering the choice of material for constructing a water supply system, where wood is not available, one should observe the effect over the years of metal coins, which have been thrown ritually into springs, and choose

the metal of those coins which seems to keep the spring healthy. If we study the water supply systems of the ancient Romans, we note that the drinking water was supplied either through wooden pipes or along natural stone channels. Later on, as the towns grew and the water requirements increased, the unfortunate choice was made to supply both drinking and bath water in metal channels.

Other ancient waterworks of great interest were the underground irrigation canals built in Eastern Turkestan. They were maintained and functioning even during the 1700s, and their remains were studied by Sven Hedin during his travels in Asia.<sup>8</sup> Water ran at great depth in these canals, and flowed in darkness to the areas to be irrigated, and Schauberger thought that this method of transporting water in darkness and coolness was one of the reasons for the fertility that was once a characteristic of the oases in Eastern Turkestan.

Such historical observations were very interesting. They showed that people formerly had had a clearer understanding of water's true character than today. But in the final analysis, Schauberger always fell back on his own observations and his own situation. It was this intuition, this deep perception of Nature's hidden relationships, that led Schauberger to attempt to copy natural processes, and which also enabled him to come to such unusual conclusions about what he saw in Nature.

Natural phenomena undisturbed by man point the way to the realization of a new technique. One needs a keen sense of observation. We must understand Nature before we can adapt its way of working to our needs. As a gamekeeper in a remote forest region hardly visited by man, I was able to make these observations and they led me to the idea of implosion.

In Hetzau, below Ring, lie the Od Lakes (Odseen). After a long spell of hot weather a thunder-like noise (buhlen in the local dialect) is often heard coming from the bottom of the lake, accompanied by a water spout

One hot summer day I sat on the bank of the lake and wondered whether I should cool down by taking a refreshing bathe. Just as I decided to jump in, I noticed the water beginning to move in peculiar spiral whorls. Trees, which



had been dumped in the lake by avalanches, began to describe a sort of spiral dance, which drew them constantly nearer, with ever increasing speed, to the centre of the lake. Having reached the middle, the trees suddenly took up a vertical position and then appeared to be sucked down into the depths by some dragging force, causing the bark to be ripped off. It could be likened to the experience of a man suddenly hurled upwards in the air by a cyclone, to crash down to earth stark naked. No tree reappeared from out of the Od lake.

In a short time the lake was again calmer, as if it had been freed by the victims which had been dragged down into the depths. It was, however, only the calm before the real storm. Suddenly the bed of the lake began to rumble. Without warning, a water spout of at least the height of a house shot upwards from the middle of the lake. A noise like thunder accompanied the turning cuplike pillar of water. Then, as suddenly, the spout collapsed upon itself. Waves hit the banks of the lake as the water began to rise in a mysterious way, and I was forced to leave hurriedly. I had experienced the archetypal expansion of water, a renewal of water in the lake, without any inflow.<sup>9</sup>

Schauberger draws an audacious conclusion from his experience by the lake. According to his theories on water, it is a living substance which is born and develops - normally to change into higher forms of energy- but can, with incorrect treatment, also die. Even a restricted volume of water can increase, not in the usual sense of expansion through heat, but instead through growth like an organism. Schauburger continues:

Naturally moving water augments itself. It improves its quality and matures considerably. Its boiling and freezing points change, and wise Nature makes use of this phenomenon to raise water, without using pumping equipment, to the highest mountain peaks, to appear as mountain springs. This conception of raising water is not to be taken literally, since in this context it is concerned with the natural process of propagation and purification. This in turn helps towards the expansion of air by creating an air cover, which serves to develop a higher form of life.

## The Full and the Half Cycle

According to Schauberger, the water's cycle from the earth to the atmosphere and back again is either completed as a full cycle, or remains a half cycle.<sup>10</sup> The full cycle can only take place where there is the appropriate vegetation cover to allow the rain to penetrate deeply, and it will in turn encourage natural vegetation and conditions of water run off. In the full cycle, when water falls to earth as precipitation, it drains through the soil, sinking deeper and deeper through rapid cooling, until it reaches a level where the weight of the water mass above equals the pressure of the deeply drained water, the latter, warmed by the earth's heat, and as its specific weight falls, wants to rise. During heating the water is able to attract and bind metals and salts. In fact, the water has been partially converted to steam during heating, and comes into contact with carbon beneath the earth, causing the reaction  $C + H_2O \rightarrow CO + H_2$ ; that means that the oxygen in the water separates from the hydrogen, and then the damp hydrogen gas forces its way towards the earth's surface with tremendous pressure. Thus carbon dioxide is released from the deeper drainage basins. At the same time surrounding salts are dissolved and carried away with the gas to be deposited again in layers near the surface, which is kept cool by the 'refrigeration' effect of the vegetation. This is how a constant supply of nutrition is made available for vegetation, and deposited at root level.

In the half cycle, on the other hand, no such nutritional flow occurs. If the surface area has little or no vegetation cover, as for example after timber cutting, it becomes warmed up by the sun. If the ground is warmer than the precipitation the moisture is prevented from penetrating the soil.

As the water sinks just below the surface, it rapidly warms up and runs off, without having been able to bring up any of the nutritional salts. It also evaporates much more quickly.

The cycle also governs the formation of subsoil water, and its relative level. Where only half that cycle is completed there is no subsoil water, or rather, it is at great depth, having been dependent on the vegetation's cooling action of the soil. If, for example, there was a dry period in a normal landscape, the evaporation rates of the trees would increase, meaning that warmth was taken away from the root areas, which cool down towards +4°C. Here Archimedes' principle comes into play as

lower layers of less dense warmer water can never lie below colder water, which has a higher specific gravity. In other words, the subsoil water level rises towards the surface and offsets the threatened drying out of the root area. If there is no vegetation then no such rise in water level can take place.

In this presentation of water's temperature changes throughout its cycle, Schauberger provides an interesting explanation of the continuous nutrition supply to the growth zones within the natural landforms, and also an explanation of the exhaustion of the soil that takes place when natural forests and healthy water conditions are destroyed.

Near the polar regions where there are winter or frozen conditions for a long period of the year, the movement of nutrition is concentrated in the spring. Snow and frozen ground effectively insulate against the atmosphere, and the soil's warmth is maintained under this insulation blanket until the spring, when the sun's warmth helps to soften up the frozen surface soil. Melt water can now percolate down into the ground to deeper levels where the complete cycle can force up the nutrients to the root areas of the vegetation. The thicker the frozen soil level, the better the movement of nutrients in the spring. On the other hand, bad winters give bad harvests the following summer. (*Die Wasserwirtschaft*, No. 5, 1931.)

Following forest clearance the water level drops, interrupting the otherwise continuous transport of nutrients from underground. It may be clearer now why modern forestry techniques require the artificial fertilizing of their commercial forests, as the normal nutritional build up that Nature normally provides can no longer take place.

Schauberger did not approve of pumped subsurface water as drinking water. This water forced artificially from the depths was 'immature' - it had not yet passed through the whole of its natural cycle, and therefore in the long term would be injurious to man, animals and even plants. Only the water that runs out from the soil by itself in the form of springs and streams is suitable as drinking water.

The tapping of the earth's subsoil water resources contains, according to Schauberger, a double risk; these reserves of 'immature' water are used up, and also this water acts in a negative way upon all living biological processes. Instead of imparting energy to the drinker, it takes energy for itself from the organism.



Haravatts River in Jamtland (Nils John Norenlin).

Water flowing from a natural source, particularly a mountain spring, acts in quite a different way. Schauberger found that if one drank a litre of this water - thus presumably increasing one's weight by approximately a kilo - the net increase in weight was in fact only 300-400g. The remaining water must have been converted directly as energy to the body, thereby explaining the enormously enlivening quality that this water gives. It was this type of water that Schauberger strove to produce by machine, using his 'repulsator' which is described below.

### Artificially-made Spring Water

Early on Viktor Schauberger had thought of the possibility of producing good drinking water artificially. By using a machine that copied Nature's methods of building up water, it should be possible to create spring water, and so support people who could not obtain natural water because of environmental destruction.

As long as man had not disturbed the organic balance and Mother Earth was able to donate her blood - the water - to provide a healthy vegetation, there was no need to construct artificial canals, since the earth already provided waterways. Today, however, where nearly all the healthy springs are either dried up or the water is diverted from its source and is led through badly constructed pipes, all of life is dependent upon stale and therefore unhealthy water. Water supplied to housing estates for human consumption through inferior systems is infected with chemicals. It is desperately important to rediscover Nature's ways if human beings, animals and the land are to be saved from decline and the earth is not to die of thirst

It is only Nature which can and must be our teacher. If we want to be healthy we cannot merely rely on local mechanical or hydraulic action for our water supplies. We must try to understand how Mother Nature transforms water into the life blood of the planet and makes it available to us, pure and life giving. If we succeed in this quest there would be no reason why the earth could not be transformed into a garden, supplying unimaginable and delectable harvests. Good mountain spring water differs from atmospheric

(rain) water by its suspended matter. Besides the dissolved salts, mountain spring water contains a relatively high content of gases in both free and fixed form as carbonic acid. The gases absorbed in a good mountain spring consist of 96 per cent carbon matter. By carbon matter in this context is meant all carbon matter known to the analytical chemist, all elements and their compounds, all metals and minerals; in other words, all matter with the exception of oxygen and hydrogen.

Atmospheric water (rain water, condensed water, distilled water or water exposed to a strong current of air and intensive light) as for instance surface water, contains a relatively high content of oxygen, almost no or limited salt content, no or only a small amount of free and fixed carbonic acid and a gas content absorbed from the air consisting of oxygen which is preponderately dissolved in physical form.

There are different ways in which the suspended matter is carried in solution in water. And just as the chemical composition of the solution can vary, so can the type of solution indicate the kind of energy that is at work in the water. Accordingly we differentiate water which contains a high percentage of energy derived from carbon matter, from water which exhibits a high percentage of energy derived from oxygen.

Water which sinks into the earth from the atmosphere will pick up salts and minerals and other substances which restore its vitality; it is enlivened by isolation from light and air. But there is also a certain journey in both time and distance that the water must make underground before it becomes internally mature. Water is mature if the air it has absorbed contains at least 96 per cent carbon content of which there is a proportion of solid matter. From this inner maturity the quality and the internal strength of the water depend.

Schauberger now began to attempt to reproduce these stages. He built the first so-called water refining apparatus around 1930, and finally developed a model for which he sought a patent

He started with sterilized water from the Danube, added small measures of certain metals, minerals and carbon dioxide,

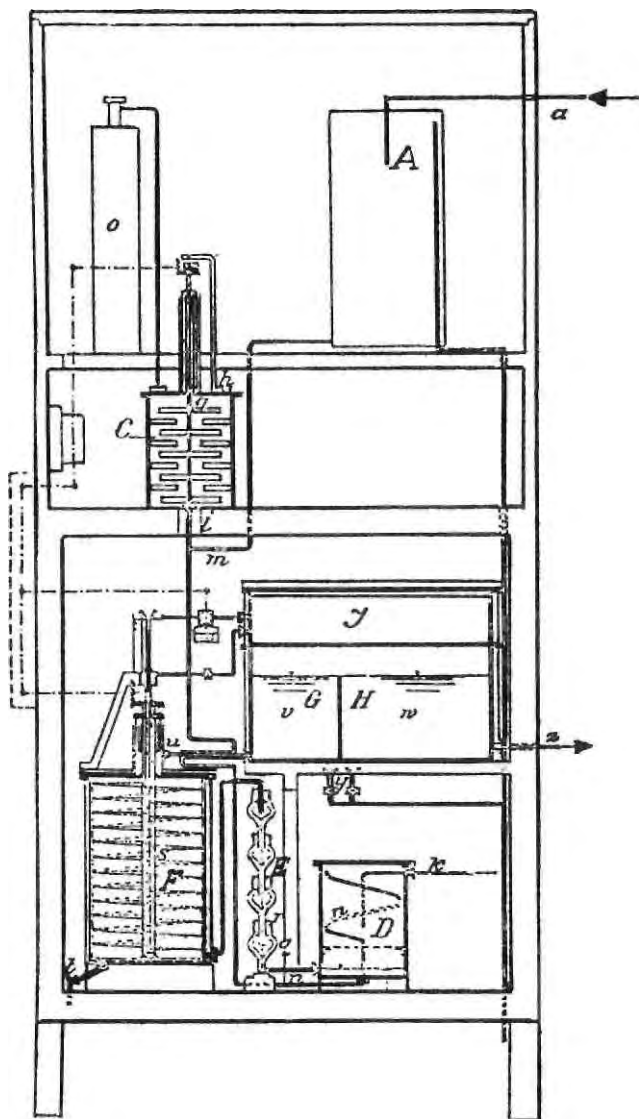

An earlier type of apparatus for the production of 'living water'. Sterilized water from container (A) is mixed drop by drop with the salt solution from (C). The mixture then passes to (D) where it sprays out from the perforated pipe 'n', while carbon dioxide is being introduced via pipe 'k'. Water falls in droplets to the bottom of (D) while absorbing carbon dioxide, and is led to (E) where it is forced into a meandering motion onto (F) where it passes over gold and silver filaments, to finally gather and cool in the silver lined container (H), until it slowly reaches  $+4^{\circ}\text{C}$ .

and let the mixture undergo cycloid spiral motion in darkness, while allowing its temperature to fall towards water's 'biological zero' (+4°C). The whole process was an attempt to copy water's natural journey in the earth as he understood of its 'full cycle'. After a short storage period the water was allowed slowly to increase in temperature to +8°C, and was then ready to drink.

Rumour soon spread that Viktor Schauberger could make 'living water' and people streamed to his home to try it. The general opinion was that the water was very refreshing; the sick felt better, fevers abated and recovery quickened. Schauberger had already been nicknamed 'water magician' when building his timber chutes, and now he was really thought to be one. Specimens sent to laboratories for analysis showed that Schauberger's water could not be differentiated from spa water.

The first apparatus was, however, very complicated both to build and to operate. Schauberger strove therefore to construct a more 'natural' model. After a while he developed an apparatus resembling that shown on p.62. Realizing the importance of the correct shape for the development of the relevant motion, Schauberger chose the shape of an egg, which he considered Nature's most ideal form. The materials used in his 'egg' were crucial; he experimented with different alloys of 'pure metals', until he found one he considered suitable. The vessel had a vacuum-tight lid which allowed filling and draining with an inlet for carbon dioxide. There was a meter to measure the 'biological vacuum' that should build up within the container, if the process was to function correctly. The agitator was an important part of the apparatus, which stirred the water in a cycloid spiral motion. The agitator's shape, the number and direction of revolutions, a certain rhythm in 3/4 time, were all critical factors. The vessel also had to be well insulated with a suitable material to prevent the energy created within from radiating outwards. This energy should instead be returned in the water to give it its high quality.

### A New Type of Pipe for Drinking Water

Schauberger's plans for healthy drinking water also included the redesigning of water pipes made of new materials. He was



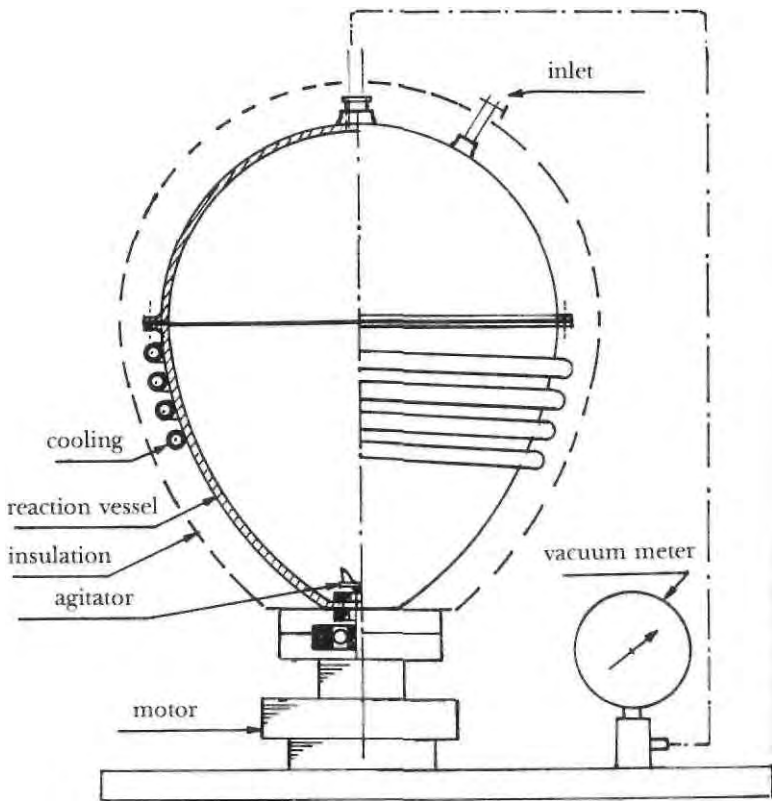

A schematic diagram of the apparatus for biosynthesis. The ingredients for biosynthesis are added together within the airtight egg shaped vessel made of synthetic material. The contents are then set into a hyperbolic centripetal spiral motion by the specially-shaped agitator. A cooling coil provides the appropriate temperature control. The vessel is enclosed within an insulation shell of hydrocarbon material to restrict the loss of 'implosion energy' created, instead concentrating it within the vessel so that biosynthesis can take place. The vacuum meter monitors the 'biological vacuum' formed if biosynthesis succeeds.

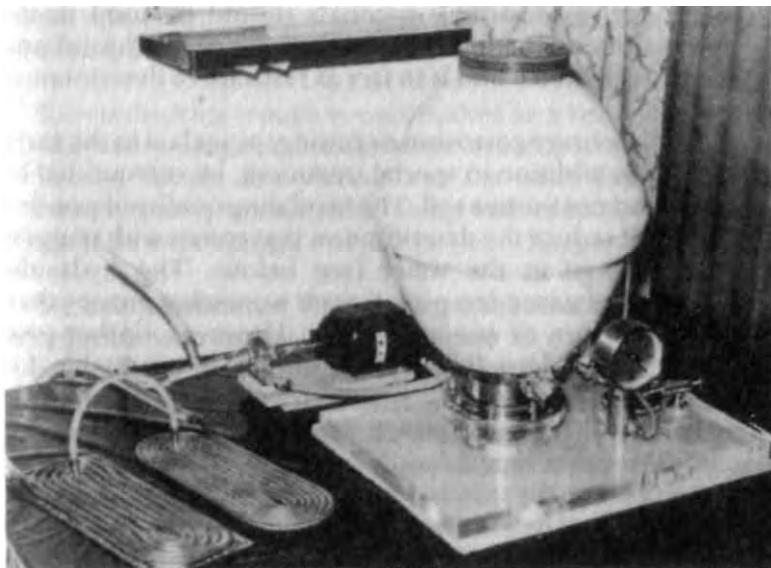

Apparatus for biological synthesis of spring water, constructed by Swedish biotechnicians (see p. 129).

most critical of iron or concrete pipes, which he thought especially ruinous to water and a cause of cancer.

The capillaries in the bodies of animals and plants serve as conductors for blood and sap and for the maintenance of the whole structure. In the same way, the supply pipes for drinking water should be seen as capillaries in order to discourage physical deterioration of the pipe (through the wrong choice of pipe material) or harmful properties in the water itself. Human beings or animals can thus become affected. The walls of our drinking water pipes must be made to encourage water to flow as it does in Nature, otherwise the water pipes themselves will be corroded or the human blood vessel system damaged, causing dangerous illnesses like cancer.

If this deterioration of the quality of water is to be avoided, the material used for the main supply must be so chosen that it is organically compatible and above all a poor conductor of heat, like sound healthy wood. Artificial stone

is about as unsuitable as metal for conducting pure drinking water, for only natural materials should be used in the process of conducting the blood of the earth. Sound and correctly treated wood is in fact as resistant to deterioration as iron.

To discourage corrosion or rotting, pipes laid in the earth should, in addition to special treatment, be surrounded by sandy and not humus soil. The insulating quality of wooden pipes will reduce the deterioration that comes with temperature change in the water (see below). The hydraulic efficiency of a wooden pipe is even somewhat greater than that of an iron or concrete pipe.<sup>11</sup> However, timber produced by modern forestry techniques is unsuitable for conduit work, since it has neither the same quality nor the durability of naturally grown wood.

It was not only the material within the pipe that Schauberger had in mind that determined the quality of water, but also its shape, which influenced the water's form of motion. Poor

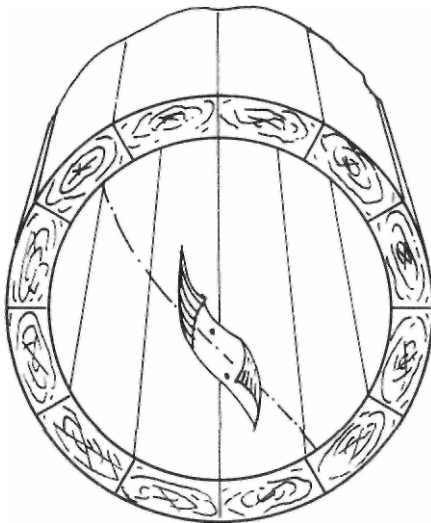

A double spiral pipe. The pipe, preferably made of wood, has guiding edges of pure metal (e.g. copper or silver) attached to the inside. These force the water into a spiral motion, which should increase its quality, while at the same time considerably reducing the resistance in the pipe. (Austrian patent 13 82 96.)

quality could be improved with the use of a spiral of certain metal alloys in sections of the pipe system. Schauberger obtained a patent for this in 1934.

If a conducting trough is constructed in a naturally correct way with a form of double twist, as can be seen in freely-flowing brooks and rivers, then the water flowing in the trough is cool, fresh, full of energy and contains little gas. It sparkles with energy.

He also maintained that pathogenic bacteria in the water disappears with the use of these pipes.

Schauberger also thought that pressurization of water by pumping was harmful. It becomes deadened in the same way as water that passes through the turbines in power stations.<sup>12</sup>

Schauberger's proposals for the natural treatment of water were most controversial:

1) Water must be allowed to flow and mature in its own natural environment, which, amongst other things, presupposes a naturally-grown forest containing a great variety of species. Both single crop forestry and clear felling must cease.

2) All watercourses, from the little stream to the mature river, must have banks grown with trees and bushes to give natural shade.

3) Water installations (dams, power stations, etc.) must be sympathetic to water's needs and must not alter its natural forms of motion.

4) Water pipes, and other water transporting methods, must be so designed and of such material as to promote the preservation and development of water's particular biological quality.

## 4

# THE LIFE AND DEATH OF A FOREST

### The Natural and the Artificial Forest

Viktor Schauberger saw the forest as the prerequisite for healthy water, for a sound build-up of nutrition, and for maintaining a sound human culture. The definition of the term 'forest' was for Schauberger totally different from that used by modern commercial forestry. Schauberger's 'forest' is a naturally mixed forest, with many species coexisting in ecological harmony. He wrote in 1930:

A healthy forest, untouched by forestry technology, is made up of a strange mixture of vegetation. Alongside well-defined areas of noble trees, conditions of apparent chaos can be found, which can best be described as irregular confusion. People who are not aware of the importance of the balance in Nature, of which the forest is a part, want to clear areas of everything they do not consider to be useful. A great deal of sensitive concern and observation is necessary to begin to understand why Nature depends on an apparently chaotic disorder.

Modern forestry is completely unrelated to the forest's natural life, but, instead, upsets the whole balance of growth and creates chaos.

At one time the young sapling lived for decades in the healthy naturally-growing forest, uninfluenced by man and his technology, as part of the healthy growth protected by the mother trees and responding to the harmonious balance of temperature, humidity and light.

With the death of the mother trees, the saplings nearing maturity reach out to enjoy the direct light and warmth; the period of early growth, shown by the very narrow annual rings, is already over. The conditions of increased light and warmth accelerated the growth of the younger trees. It is important that the trunk of the tree remains protected from the direct influence of the sun except for the crown.

The commercial forester, aware of the effect of light-growth, envisaged a scientific method of achieving the same results. He drew up a new blueprint for growth, which, although in conflict with the natural order was, in his opinion, more effective. This new technique for forest development subjected the saplings to too much light and warmth and an excessive growth of the annual rings. These new methods have resulted in the system of laying waste whole areas of trees. As a consequence, certain forms of undergrowth have disappeared. This was thought to be of no disadvantage, because it avoided the necessity of draining this type of ground, which was of no value.

Inevitably, this new form of timber industry has left those trees standing which grow in the shade and thus are light sensitive, without the protection of the old trees vital for the natural rejuvenation processes. The centimetre-wide annual rings on fir trees, caused by the sudden denuding of other trees in the immediate vicinity, produce spongy wood of inferior quality, and after cutting it is evident from the rings that there is a loss of consistency. After the drying-out process, these spongy areas contract in a different way to healthy wood. Clearly, such wood should not be used for house construction. Since the introduction of scientific methods of arboriculture, the highest quality wood, the so-called 'resonance wood' has disappeared completely.

This slow growing wood differs from the fast produced by modern methods by the annual rings, which are difficult to distinguish. The organic structure of the natural wood shows a fine homogeneity. The wonderful timbre of the instruments made from this wood (which Stradivarius used for his famous violins) shows that it is not only healthier, but also has an almost unlimited durability. In comparing the properties of wood produced by modern forestry practice with this wood of supreme quality, one begins to realise the almost irretrievable loss we have suffered through blatant

misunderstanding of natural processes.

One might ask how can we continue to use a forestry technique, which after barely a century has been responsible for such catastrophic results, jeopardizing the future of all forests? A return to Nature and her processes is now becoming increasingly urgent. The forest is not a resource to be exploited, but a vital organic part of each culture, particularly in the mountain regions. Social deprivation becomes greater as a consequence of today's destruction of the forest.

What at first sight appeared as a great source of wealth, even a scientific breakthrough, has since been revealed as a calamity. Perhaps it is too late to avoid cultural decline as a result of our mistakes. It is clear that the extermination of a type of tree creates a gap in the ecological balance because its destruction can lead to the disappearance of another type. This has the effect of reducing the supply of deep ground water and its accompanying nutrients. The timber needs of our modern construction industry has led to the clear felling forestry economy with its forced replanting methods, resulting in a general decline in the quality of the timber.

The disturbance of the forest's natural balance has also far reaching consequences as the whole nutritional supply for the surrounding landscape is seriously damaged.

As a result of the wholesale clearance of forest areas and the dying out of certain types of wood, the soil starts to lose nutrients. The sun's rays are now able to reach the soil surface, causing it to warm up. This means that the ground water containing the essential nutrients is prevented from rising, and the vital salts are deposited below the root level of the saplings. The roots can no longer reach the nutritive layer deep in the soil. Soon the vegetation will diminish and the decline to desert waste begins.

Schauberger points out that a natural forest has an average temperature in the root zone of +9°C. This temperature must not increase if the natural growth process is to continue.<sup>13</sup>

### The Forest as the Landscape's Power Centre

Schauberger emphasized that the natural forest is a power centre for the whole of the surrounding landscape. He sees each tree as an energy-laden body in which a number of complicated processes occur, and which radiates energies into its immediate environment. These energies, 'horizontal ground rays', which also emanate from natural watercourses are not only a basis for vegetation growth, but also help build up ground water.

The damage caused by modern forest technology is so devastating, because this energy interchange cannot evolve as it does in a natural forest. When there is a variety of tree types and undergrowth, energy is created in the whole forest area.

Schauberger also stresses the important role of trees as mineral processors, building up metals and minerals, through biochemical reprocessing and biodynamic circulation:

Each green leaf or each needle is in effect a remarkably well-regulated metal factory. Its operation can be demonstrated experimentally. With the falling of the leaves or needles this supply of metals is scattered by the wind, and the more undergrowth there is, the greater is the dispersion of organic metal salts, which during the winter are pressed down hard by the snow.<sup>14</sup>

These metals play a large part in the build-up of the 'insulating skin' that Schauburger thought so important for the living processes within the soil. They form an extremely fine material lattice on the ground surface, a type of organic diffusion filter that separates the negatively-charged ground from the positively-charged atmosphere, a prerequisite for the growth process.

In this way, the trees build up important metals needed by plants and man, particularly in the form of trace elements. The watercourse flowing out of the natural forest carries with it some of these metals and deposits them in the surrounding environment. These trace elements contribute to the basic make-up of living water.



Besides its well-known ability to ameliorate the climate, the forest has also, according to Schauberger, a series of vitally important functions. He calls this the 'water's cradle', a vital factor in the provision of ground water. It produces trace elements and minerals, and it creates energy to make nutrition available.

### The Biological Consequences of the Destruction of Forests

Viktor Schauberger was certainly one of the first in the world to warn about man's encroachment of the natural forest. His bitterness and worry about the plundering of the forests that commenced after the First World War in Austria and Germany was expressed movingly in his speeches and writings. He entreated the authorities, in his attempt to awaken public opinion to this 'final sale' of the landscape. He wrote in 1928:

What can be said about the forest and its life? Unfortunately, my task is to write about its death. It is vital to alert those men who are still in a position to save the dying forests from the hands of those who have no feeling for, or awareness of Nature.

When a man dies the bells toll. When the forest dies and



Preparation of ground surface after felling by the Deman works in the Gallivare region (Pal-Nils Nilsson/Trio).

with it a whole people perishes, not a finger is lifted. It is known that for the death of a people the death of a forest has preceded it.

It may be hundreds of years before the forests return to the same standard as they were a few decades ago.

The general public is not aware of this slow decline of quality. People see forests everywhere and are deceived by statistics, which report that there is more timber produced per hectare today than previously. This merely conceals the real truth - that the quality of the remaining forests is declining at a frightening rate.

He had learned from bitter experience that the destruction of prime forests led also to the disappearance of water. In 1930 he wrote:

The finest memorial which could be given to a man, would be if he had the power and the will to end this senseless destruction of the timber forests. Tragically, the significance of the forest in relation to the life of a people is not appreciated in anyway. The forest is both the cradle and the haven for the divine water, if man destroys this haven then the water becomes redsdes and of the greatest danger. Without the forest, no water, without water, no bread; without bread, no life.

One eventually comes to the conclusion that all today's failures derive from the mistakes which have taken place in the ground, in the water and in the air.

It is not a question of the forest remaining unutilized by man; but present methods make no sense and display a total ignorance of the laws of forest and water.

So long as a waterway is able itself to transport a log, the forester may use his axe. The deterioration of a waterway is a warning of danger, which, without exaggeration, threatens our very existence.

So long as the forester does not interfere with the natural order of the forest, the stream, which flows through most forests, will deliver almost without cost the fruit of the forest, namely, the timber.

If, on the other hand, the forester (in this case, a forest

destroyer) so operates that he changes the basic concepts under which the forest can thrive (by, for example, wholesale timber felling), then Nature will react to protect itself. The destruction of the forest leads immediately to the destruction of the waterways, the only profitable means of transport.

The wholesale destruction of forests continues and everywhere the consequences are frightening. The sinking of the ground water level, catastrophic flooding, irregularities of precipitation, agricultural decline, - all this and more are the consequences of mismanagement

Man has introduced the crudest possible methods of tampering with Nature's self-regulation without the remotest knowledge of how the natural order properly functions, or of the laws of natural movement. There is complete ignorance of the relationship of the forests and vegetation to fertile soil, which is in fact so similar to that of the skin to the human body. Man puts a tremendous effort into developing a forest, with the sole purpose of exploiting everything that it contains, even though its price is the total destruction of the forest environment

The most astonishing fact however, is that despite all the evidence of malpractice and economic decline, the irresponsible methods of forest treatment are still in use, which inevitably means that the forest as the basic requirement of every culture, is doomed to die ...

Even though this was written in the 1930s, it has a burning relevance for the 1980s.

At a time when millions of men are unemployed and miserable, the forests should be built up again with their waterways and storage lakes, so that the right balance is restored. Then the streams would once more supply healthy water. Such a scheme would get rid of idleness, which has already resulted in severing all relationships with Nature, and is literally the last hope for rehabilitation.

Schauberger sees the natural forest as the base for all the build-up of quality of water and nutrition. If the natural forest is destroyed, natural biological water is first affected, and,

then, the build-up of all other organic material. The biological quality of the nutrition is diminished, and people become more and more vulnerable to illnesses stemming from deficiency, circulatory diseases, and finally cancer. This, for Schauberger, was the logical consequence of the disruption of the forest's and the water's natural processes. Thus, the husbandry of the natural forest is a question of the survival of mankind:

Without a healthy forest, there can be no healthy water, no healthy blood. It follows from this that resulting from the present methods in forestry and water management, a deterioration of the fundamental quality of living takes place.

Schauberger had seen with his own eyes how the destruction of a forest region quickly led to biological changes. He relates one of his experiences: in Salzkammergut there was a spring considered to be poisonous. It had been enclosed to prevent grazing animals drinking from it. Schauberger came to the place in the company of an old gamekeeper, who warned him not to even approach the spring. Schauberger's dog, during an unguarded moment, drank from the water, and after an hour's lapse was still full of vigour. This prompted Schauberger to himself have a drink. At first he felt dizzy, but his sensation soon gave way to a noticeably refreshing feeling. He explains:

In the vicinity of the spring, traces of the presence of mountain goats were found. Surrounding the spring were mountain plants, which left an oily film on our mountain boots, which also could be seen on the surface of the crystal clear water.

Particularly striking was the blood-red colour of the Alpine roses. They surrounded the spring like a blood-red carpet. The leaves of these roses were as if sprayed with gold dust, which under the magnifying glass were found to be scales. There was undoubtedly a metallic content in these leaves.

The water here did not freeze during the severest winter, where, at this altitude, minus 30°C was not uncommon. The old hunters set their fox traps at such springs. They were covered with moss and thus not exposed to light. They

never froze, and kept the bait soft and odourless. The colder the external temperature, the warmer was the water. With an air temperature of  $-30^{\circ}\text{C}$ , the water temperature rose by  $10^{\circ}\text{C}$ , while on a particularly hot summer's day, it always approached the 'anomaly' temperature of  $+4^{\circ}\text{C}$ .

This took place just before the First World War. During the war, a depth of about 600 to 800 metres of forest was cut down. In the following spring, the spring already began to dry up. The oily film, mentioned above, completely disappeared. The water became stale and first the medicinal crops in the vicinity disappeared, then the short grass, of which the goats were particularly fond, died off.

Suddenly mange appeared in the area, which hitherto had been completely free of this disease, and gradually all the goats fell victim to it. Goats only survived if they did not stray from the springs or from where no wholesale timber clearance had taken place.

It was through systematic and thorough observations of this kind, that it can be shown that water cannot rise high and the inner growth cannot be stimulated, if the heavy metal matter begins to fall out because of the weakening of the earth's strength through excessive timber clearance.

Due to timber clearance, the metallic types of medicinal herbs can no longer thrive. The goats cannot regenerate their blood, through the crops which are necessary for them at these altitudes.

Schauberger meant that, in the long term, mankind would be affected by the uprooting of forests, in the same way as the mountain goats.

Viktor Schauberger's understanding of forests can be summarized as follows:

- 1) The forest must not only be thought of as a source of raw materials and a base for material well-being. At the same time as being a vital life source for water and the fertile mouldy soil, it also generates energy and builds up a vital environment even beyond its boundaries. It is the cradle of living water.

- 2) Without a natural forest, where many species of trees, bushes, and herbs are allowed to grow naturally and

inter-relate both above the ground and in the root areas, the full cycle of water will not be properly completed. This is necessary in order to bring up the salt nutrients and trace elements to fertilize the mouldy surface soil.

3) Without natural forests, water cannot flow from springs and streams when it has matured within the soil, and it cannot then continue to develop and fulfil its natural functions on the surface without the forest cover.

4) A natural forest is like a power centre that sends out energy in flowing water to the surrounding environment

5) The so-called rational forestation with its method of plantation, thinning and clearing, disturbs the complex relationships upon which the quality of all living organisms depend. Such forest exploitation becomes a threat to mankind itself, through its biological degenerative effect on water and foodstuffs.

### The Green Front

Viktor Schauberger, together with his engineering son Walter, founded an organization in Austria in 1951 to encourage the protection and regeneration of natural forests, and promote environmental protection in general. This organisation, The Green Front (Die Grune Front) found a wide appeal, and it was in no small measure due to its work that responsible authorities in Austria finally woke up to the fact that the destruction of forests must cease. At the Forestry Charter Meeting in London in 1951, the two pioneers of The Green Front were praised for their contributions.

## PERPETUAL MOTION

Panta rei  
(‘Everything is in motion’): Heraklitos

### The Two Forms of Motion

Though Schauburger was mainly engaged with building flotation installations until 1939, he also busied himself with many other problems. In addition to methods for regulating and regenerating water, he was fascinated by the production of useful forms of energy. Through observations and experiments he had become aware of the contrast between Nature's way of working, and man-made technology. He became more and more convinced that human technology is life-threatening and inhibits evolutionary growth. It is not just a question of air and water pollution. Though they were serious in themselves, he saw these absurdities as secondary problems. The fundamental question is: must there not be something basically wrong with the principles behind modern technology to have led to such serious consequences for forests, for water, for soil; and all life? A technology that produces such upheavals in Nature, or at very least achieves such poor results, must be altogether wrong. This question of performance had long troubled him. He said about this: ‘Our modern techniques behave like a farmer, who in the spring plants seven potatoes and in the autumn harvests one.’

The steam and internal combustion engines, upon which the modern world depends, do not even work to a 50 per cent efficiency. More than half of the energy used is destroyed or useless. Why do they perform so badly? Nature soon provided him with an answer to this question: ‘We use the wrong sort of motion.’

All he had perceived of the circulators' motion of water, of blood and of sap, now showed itself to have a universal application. There exist two forms of motion within Nature—one that breaks down, the other that builds up and refines; both always work in co-operation with one another.

The form of movement which creates, develops, purifies and grows is the hyperbolic spiral which externally is centripetal and internally moves towards the centre. We find it everywhere in Nature where growth or movement is taking place, in the spiralling of the nebulae in space, in the movement of our planetary system, in the natural flow of water, blood and sap. On the other hand, the destructive and dissolving form of movement is centrifugal in Nature—it forces the moving medium from the centre outwards towards the periphery in straight lines. The particles of the medium appear to be forced out from the centre. The medium is first weakened, then it dissolves and breaks up. Nature uses this action to disintegrate complexes which have lost their vivacity or have died. From the broken-down fragments, new co-ordinated forms, new identities can be created as a result of this concentrating form of movement. The centripetal, hyperbolic spiral movement is symptomatic of falling temperature, contraction, concentration. The centrifugal movement, on the other hand, is synonymous with rising temperature, heat, extension, expansion, explosion. In Nature, there is a continuous switch from one movement to the other, but if development is to occur, then the movement of growth must be predominant.<sup>15</sup>

### Death Technology or Biotechnology?

How is this relevant to our present technology? Schauberger states as a central theme of his teaching that the whole of our modern technology is built upon the idea of breaking down, through the medium of heat, combustion, explosion, expansion. It occurred to Schauberger that the poor results found in modern technology come from Nature's resistance to man's single-minded pursuit of destruction and decomposition. The overheating problem, air resistance, temperature and sound barriers, are evidence that man is on the wrong path.



Our technology points to death. It squanders coal and oil, which have more important ecological roles than to be burned in stupid machines with waste products which poison and pollute our whole environment

These are courageous opinions for Schauberger to have expressed as early as the 1930s. Today these views are not so strange to us, living in the middle of an environmental crisis, hearing daily about the harmful side-effects of technology's wastes. Schauberger's theme of the wrong motion is not yet acknowledged, and man continues to break Nature's laws, by following a destructive motion which brings chaos and anarchy to our world. If Schauberger's thought are correct, it is of little avail to try to develop exhaust filters, or sulphur-free oil, or absolutely safe nuclear power stations. None of these can eliminate the destructive influence on all living things,



Water pollution through the release of industrial waste into the River Fyris (Stig T. Karlsson).

brought about by the technical principle used in explosive power, or through the splitting of the atom.

Schauberger wanted to demonstrate another way - a biotechnological way - of producing energy, a method of using the cycloid form of motion for the positive production of energy from air and water. The splitting of the atom and the development of nuclear energy heralds the commitment of our society's future to total destruction. In his last years Schauburger tried to awaken us to impending catastrophe.

[Our object] must therefore be to publicize widely and above all to put before the Government the fact that the Einstein theory of energy gain through the splitting of the atom is an offence against Nature, and that one can make use of atomic power through the biotechnology of implosion.

Schauberger strove to duplicate Nature's implosion through the design of his 'implosion machines', which he claimed were unique in that they needed no fuel.

In the case of a power generator, nine times as much energy in the form of fuel is required in the conversion to electricity or other kind of output. This system of plundering the resources of the earth, which has resulted in the murderous scramble for the earth's energy, is based upon the explosion motor, which operates centrifugally. The implosion motor, however, is centripetally operated. It produces its own driving source through the diamagnetic use of water and air. It does not require any other fuel such as coal, oil, uranium or energy derived from atom splitting, since it can produce its own energy (atomic power) by biological means in unlimited amounts - almost without cost. It has been overlooked that energy is also bipolar and appears freely as part of the motion of the earth's medium - water and air, which have the effect of reviving energy. The type of energy can be either bio-electrical, that is destructive, or biomagnetic, ie. levitative.

### Implosion and Diamagnetism

Schauberger tried to explain the natural phenomena that gave rise to the understanding of implosion power and its associated

'diamagnetism',<sup>16</sup> and their opposites in the following way.

Let us begin with the most elementary aspect: the basic elements hydrogen and oxygen, the chief components of water and air, oppose each other in the following manner

Hydrogen (H) becomes active by cooling and combines with the passive oxygen (O) to produce a concentrated form of energy of lift and growth, 'biological magnetism'. This lifting power of diamagnetism operates in opposition to gravitation. In the case of hydrogen gas, which was used to fill the Zeppelins, the lifting force amounted to 2km per second. Above all the 'play of nature' turns on these two forces. Thus the biological magnetic or levitation tendency of the plant as it is attracted towards the light, influences its growth, while simultaneously increasing its weight and consequently the force of gravity. As iron and steel are attracted by magnetism so the elements hydrogen and oxygen, essential for sustaining life, as also are the highly valuable trace elements - the 'chromosomes' of water and air - are attracted by diamagnetism. It is the opposite to electricity. Stale water is reactivated and increased in volume through biological magnetism.<sup>17</sup>

Oxygen (O) is activated by heat (every oven burns better by adding oxygen!) and combines with the then passive hydrogen (H) to produce a dispersing energy which results in decomposition. This occurs with every explosion. It is produced whenever pressure, heating and explosion are used and is particularly found in weapon design and atom splitting, whether for war or peaceful purposes.

Heat is the lowest form of water decomposing energy. As the molecules are redistributed, heat is generated (the predominating H combines with O, instead of O with H, as would be necessary for organic growth), then the water (as in the sap of plants and blood) becomes stale, lacking in higher quality matter (which burns up due to the excess of oxygen). Decomposition sets in, cancer develops and at the same time the decomposing element traces and pathogenic bacteria multiply, overcoming the natural restorative processes of higher forms of organic life.

The molecular build-up of cancer growth, causing fever, is stimulated by impulses of a physical, chemical and a psychic nature. All energy (heat, electricity, magnetism, or

diamagnetism) is the result of bi-polar action, originating in mutual attraction. The whole universe is composed of living organisms, which with little effort can be forced into a straight-jacket by the human operation of using hammer, tongs, hatchet, screws or explosives, and with even less effort can be made to produce in abundance. It is not pressure, but attraction that the 'eternal woman' employs; so we can talk of negative pressure, or the negative electricity of diamagnetism.

The invention of the 'suction spiral' and the 'suction turbine' is based on the same principle as the twisting action of rivers, which is caused by the movement and rotation of the earth. In the river, the water is thrown hither and thither, spins, reels on itself, as the rope in the hands of the ropemaker. It forms whirlpools, eddies, spiral-forming currents, where the water rotates on its own axis and condenses. Vacuums are formed, creating a negative pressure, which affect the breathing of the water through suction, and this generates a cool air stream. This is the 'falling temperature phenomenon', which physics has not considered to be mechanically produced. It is, however, produced in the suction turbine, which rediscovers an ancient principle.

The problem is solved. We are now in a position to convert the present 'fire technology', one of destruction, into a technique of life, to convert explosion motors into implosive.

Schauberger does not limit these energy effects to a local scale, but insists they apply to all of life, even on a grand scale.

If this decomposing energy, which in Nature is a retarding force, is produced by centrifugal force mechanically, in uncompromising opposition to Nature, then cancer is likely to develop. Eventually this may have the effect of making us cease trying to manipulate Nature, and in the long run increasing our chances of survival.

For Schauburger, then, it is the reliance of technology on the principle of explosion that is the universal problem. A change of attitude, leading to the development of constructive energy

generation, would open immense possibilities for mankind to influence the creative evolution of Nature.

If, on the other hand, human existence were to develop natural centripetal movement in air and water, negative pressure could be activated to release certain trapped forms of energy. The trace elements and 'chromosomes' in the water and air provide atomic decomposing energy from previous higher forms of life in which they were contained, and which merely await an impulse to be revitalised. If this were to happen, the whole process of growth would be stimulated and revitalized.<sup>18</sup>

## 6

# IMPLOSION AND BIOSYNTHESIS

### Schauberger's Understanding of the Energy Question

The conventional methods of energy production are all associated with destruction, producing obvious side-effects of waste, but also more subtle effects on organic life. Schauburger was especially critical of the use of fossil fuels, coal and oil, which he considered essential in their natural state for the build up of healthy water. When the earth's coal and oil resources are plundered, it leads to the disappearance of water. Coal and oil contain high-value trace elements from earlier life forms. Nuclear power, the splitting of the atom, he saw as a watershed of life, between its highest stage and its final misery.<sup>42</sup>

Schauberger was also critical of hydro-electric power stations, though their damaging effects are not so obvious. The natural structure of the water is broken down as it passes through the turbines; the steel of the turbine has a detrimental effect on the water, which is then forced into an unnatural form of motion. He used to tell how mountain farmers in Austria were unhappy irrigating their fields with water that had gone through the power stations' turbines, as it had become impoverished.

The ringleader in this insane merry-go-round is the energy technologist. Coal, the bread of the earth, and water, the blood of the earth, when found in sufficient quantities, are the providers of energy. For the first few decades, man basked in this accidentally-found richness; but already the effectiveness of the water providing the power has been lost, precipitating a destructive cycle on the earth. As man toils with tremendous energy, so his misery grows.

## New Motor Fuel Through Biosynthesis

One alternative to explosive technology that Schauberger investigated was a new motor fuel that could be used in ordinary combustion engines, but without the dangerous waste products.

He had discovered that water in a constructive hyperbolic motion had the ability to create different forms of synthesis. He redesigned the apparatus he had constructed for his living water experiments, to bring about the synthesis of hydrocarbons suitable for fuel. He felt that it should be possible from low quality raw materials to create a product with a high energy content

He was reputed to have obtained traces of a petroleum-like product in his apparatus. He refers in his writings to 'highly potent water' that he could now manufacture in his 'repulsator'.

If water is sprayed into a cylinder and a quantity of natural oxygen is added, a light heat pressure created by a descending piston is sufficient to transform the highly potent water into a gas.

The exhaust gas from this 'highly potent water' was very similar to ordinary air, and therefore poison-free. However, there were great problems with these experiments, and he failed to achieve consistent results, even with careful controls.<sup>43</sup>

## Trout Turbine

Schauberger turned his attention to constructing a machine designed to produce energy directly from air and water. He worked in 1931-32 with Dr Winter, an engineer from Vienna. However, the results they achieved had only curiosity value. He therefore returned to the question of trout in mountain streams, and how they could apparently harness energy from the water. Finally, he was convinced that he had solved the problem. The trout takes in water through its mouth, and expels it through its gills. By trimming the almost microscopic leading edges of the gills, the water is given a strong inrushing movement (analogous to the hyperbolic centripetal spiral movement). Through the simultaneous influence of certain trace elements found within the gills, the water is changed catalytically into what Schauberger termed 'juvenile' water,

which has new physical characteristics. The water that flows from the gills along the streamlined body of the fish reacts forcefully with the surrounding water because of its different make-up. This results in a secondary system of water circulation being formed which resists the water's natural flow in the stream. By regulating this pressure with the gills, the trout can either stand stock still or move lightning fast against the stream.

He found a comparable example in the wings of birds. When air flows through the feathers during flight, strong counter circulations of updraft are formed, carrying the bird forward and upward. Schauberger used to say that birds do not fly, they are flown, and fish do not swim, they are swum. These phenomena he now wished to reproduce in his machines.<sup>44</sup>

When he stopped working with Steinhard, he took no new employment, but concentrated solely on his experiments and the publication of his warnings of the dangers of technological development. He received considerable publicity in the 1930s. The log flumes, the production of living water', and his tough stance on technology awoke both interest and resistance. There was no lack of support for those who wanted to see him immobilized.

Under very difficult circumstances he now tried to solve the problems of making a machine that copied the trout phenomena. He first called it the 'trout turbine', but later renamed it the 'implosion' machine.

The principle of this machine was that elements such as air and water should be directed through the spiral shaped pipes of a particular material, and with specially shaped cross section. The introduced element should then, at a certain count of revolutions, be directed into a corkscrew motion, at which point the energy should be released. Schauberger presumably counted on a certain reaction at an atomic level, something akin to hydro-fusion experiments all over the world. However, instead of violently compressing atoms in hydrogen gas to create helium and a release of energy, Schauberger wanted to 'screw' together his elements without resistance, in the same way as he perceived it to happen in Nature.

It is known that he built two such machines, one of which was destroyed. According to hearsay, very strong energy was



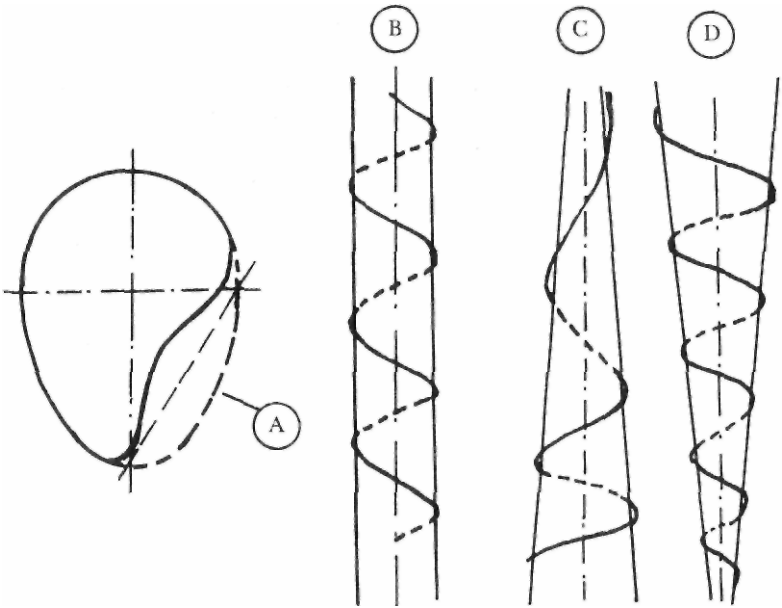

Pipes for liquids and gas. This pipe was also to be used in the 'Trout turbine'. Its cross section is shown in (A). (B), (C) and (D) are different designs of spiral pipe systems, showing the pipe to be wound around cylindrical and conical objects. (From Austrian patent no. 19 66 80).

suddenly released, causing the machine to be torn away from its foundations, to be smashed against the ceiling. He was not able to control the energy (see above).

Since he did not confide the method of the construction to anyone else, and from all accounts experimented alone, the apparatus and the details of these experiments are not known. The picture showing him standing beside such a machine is probably a variation he called the 'domestic power station', in which the small output of an electric motor was multiplied many times in a 'trout turbine', and used to drive a larger electric generator. The machine was constructed so that a conical-shaped object was set in motion within a vacuum-sealed container. A system of Schauberger's special pipes was wound around the cone-shaped object, that tapered downwards. Water entered from above and could flow through the pipes when the cone-shaped object was rotated by a small motor. Due to the pipe's shape and spiral course, the water

was 'screwed' towards the centre of the pipe (see p. 91) and sprayed out through outlets in the lower parts of the pipe, at a tremendous velocity and under great pressure. This was directed onto a turbine wheel, which powered the generator. The special feature of this apparatus was the amplification of the input energy, and the fact that the water, as it poured out of the outlets, rose to the top of the system, to be recirculated. Schauburger claimed that the water rose because it was so strongly charged with biological magnetism, negating gravity.

Schauburger also developed an aircraft engine which would work on the same principles, but using air as the fuel source. It would suck in air and convert it to fuel while flying, and at the same time create a vacuum in front of itself in which it could move continuously without resistance.

Did these machines really work, or were they just a fantasy? The evidence of the 'domestic power station' is inconclusive. According to Schauburger himself, some of his models worked, at least partially. Not even his closest associates were allowed to be present at the trials. Bauer concluded from his research that the 'domestic power station' could very possibly have worked.<sup>19</sup>

The evidence is somewhat clearer about the aircraft engines. By the beginning of World War II a model appears to have had successful trials. Aloys Kokaly tells us that at the beginning of the war he had started to work for Schauburger who was developing 'flying objects' driven by 'biotechnical' means. Kokaly produced certain parts for these engines in Germany that were hard to obtain in Austria, and took them to Schauburger, who was then living in Vienna. Parts also had to be delivered to a firm called Kerd in Vienna, working 'on higher authority' in association with Schauburger on this project. When Kokaly arrived at the firm with the parts he encountered some hostility. When he was finally received by the chief of Kerd, he was told bitterly: 'This must be prepared for Mr Schauburger on orders from higher authority, but when it's finished, it's going out on the street, because on an earlier test of one of these strange contraptions, it went right through the roof of the factory.'<sup>20</sup>

In 1945 Schauburger wrote that the working designs for an engine for aircraft and submarines were now finished, and that two different models could be built. Further tests were carried out during World War II (see p. 93).

## A MEETING WITH HITLER

### Summoned to the Chancellery

An industrial magnate, Herr Roselius from Bremen, had heard about Schauberger's 'living water' in 1934, and had contacted him to obtain the rights for Germany. It was through Roselius that Hitler came to hear of the Austrian with his original ideas about technology, and his strange inventions.

Austria was not at that time annexed, and the atmosphere between the two governments was somewhat strained. One day the German embassy requested that one named Viktor Schauberger should present himself in order to receive a visa to go for an audience with Hitler. Schauberger came to meet Hitler who showed himself to be well informed about his earlier work, and requested a thorough explanation of his ideas and his scientific research. Schauberger had requested that the meeting should be just between the two of them; this had been agreed, but as he entered Hitler's study, who should be present but ministerial director Wiluhn, the senior official of the Kaiser Wilhelm Institute, with whom Schauberger had had a bitter argument. Schauberger was, however, allowed to speak without interruption for one hour. He described the fallacies of the technologists and what he considered to be misconceptions in Hitler's four-year plan.

When he had finished, Hider asked: 'What would you put in place of the generators and methods we have today?' Schauberger answered: 'Give me facilities and staff, and the materials I shall need, and in a few months you will see my methods of producing energy. Then you can decide for yourself which is the most efficient method with the best potential.' Hitler: 'What would be the source of fuel for your generators?'

Schauberger: 'Water and air; they contain all the power we need.' Hitler now pushed a button, and the state secretary Keppler entered. Hitler told him: 'Give this Austrian, who has ideas that interest me, all he needs to prove that he is right' He then bade Schauburger a friendly farewell, who was shown out by Keppler.

As soon as Schauburger was out of the door, Wiluhn came up to him, full of indignation. He accused Schauburger of having ingratiated his way into Hitler's confidence, only to put idiotic ideas into his head. After a stormy exchange, Schauburger returned to his hotel. There he received another summons from the Chancellery, but he chose instead to return directly to Austria. For a long time he remained upset that he had had to go all the way to Berlin just to be 'abused by that underling Wiluhn'.

What he and Hitler had agreed was not carried out, but several years later it was clear that Schauburger had not been forgotten in the Third Reich.

### Electricity from Water

In 1938 Germany annexed Austria. Soon afterwards Schauburger received notice from Julius Streicher that all possible requests should be granted him on Hitler's orders. He was to be given 10 million marks to plan the forest logging and flotation structures in Bavaria, North Austria and in Bohemia. Furthermore, Professor Kotschau's laboratory in Nurnberg was to be made available for his research.

Schauberger sent a message to his son Walter, who had completed his examinations for a diploma in engineering at the technical college in Dresden, and asked him to come to Nurnberg to help with the experiments. Walter had found it difficult to accept all his father's theories, and had remained somewhat sceptical. In time, however, he became convinced that his father was right.

They continued the experiments that Schauburger had worked on earlier with Dr Winter to try to extract electrical energy directly from a water flow. At first they tried with large jets of water at high pressure from wide outlets, but without results. Walter Schauburger then reversed the conditions, using very fine outlets and low pressure and the electrical phenomena started to occur, the charge being able to be

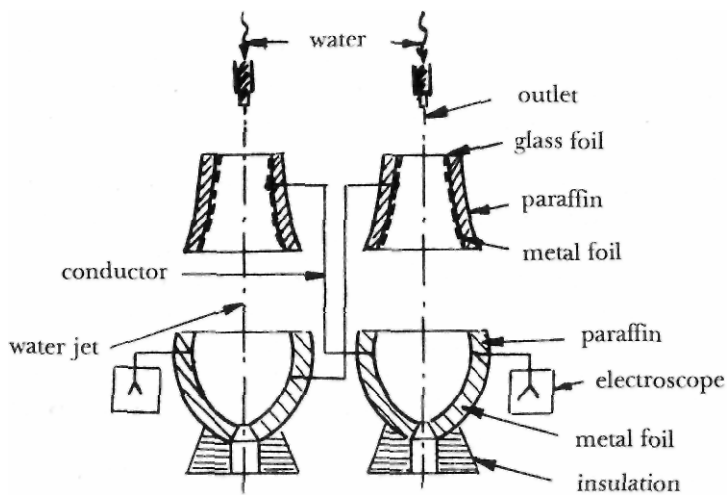

Nurnberg experiment (from Implosion No. 6).

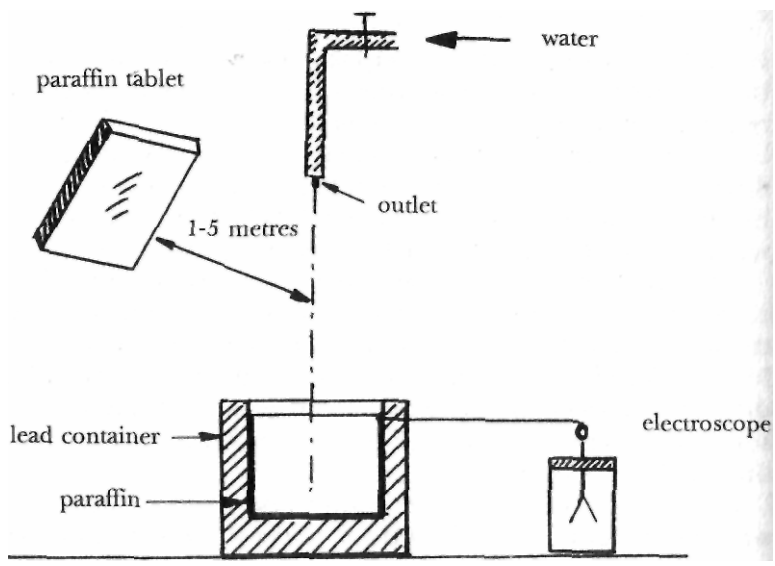

The simple waterflow test. When the paraffin tablet is pointed towards the flow the electroscopes gives a reading.

amplified to 50,000 volts. Julius Streicher was very impressed by this and sent for a physicist from the technical college to explain the phenomena. He began by searching for the electrical leads in the apparatus; when he could not find them he angrily asked Walter Schauberger where he had hidden them. That the water itself could produce such a high charge was unbelievable; but when he finally accepted that there was no trickery, he admitted that he could not explain the phenomena. These experiments with water flow did not yield any practical results at the time.<sup>21</sup>



Viktor Schauberger with a model of his domestic power station (1955).

## WARTIME EXPERIENCES

### Schauberger is Taken to a Mental Hospital

When the war interrupted the experiments in Nurnberg, Schauburger returned to Austria, and at the same time his son was called up. Some time later he was ordered to attend a physical examination, as he was soon to reach pensionable age. However, it looked as though an engineering and architectural association was behind this demand for a check-up. Without the least suspicion he presented himself at the appointed place, but was taken to another clinic for a 'special examination'. To his shock and dismay he was unexpectedly interviewed in a mental hospital. He understood that his enemies wished to render him harmless. He told himself that his only chance to get out was to remain calm and collected, and not to display the abrasive side of his nature. After a long wait he was examined by a young doctor who, after a short examination, realized that his patient was perfectly sane. He called his superior, Professor Fotzl, who immediately had Schauburger removed from the department for serious mental cases where he had been placed. After passing a test establishing that he was perfectly normal, he was brought to Professor Wagner-Jauregg, who further tested him and then released him as perfectly normal and 'highly intelligent'. Professor Fotzl was unable to discover who had referred Schauburger to his psychiatric clinic. No documents about the case ever came to light.<sup>45</sup>

### At the Mauthausen Concentration Camp

After a while Schauburger received his call-up. It was now 1943, and even older men were being drafted. He was

eventually appointed the commandant of a parachute company in Italy,<sup>46</sup> but after a short stay, orders came from Himmler that he should present himself at the S.S. college at Vienna-Rosenhugel. When he arrived, he was taken to the concentration camp at Mauthausen, where he was to contact the S.S. standartenfuhrer (standards leader) Zeireis, who told him he had a personal greeting from Himmler. 'We have considered your scientific research and think there is something in it. You can now either choose to take charge of a scientific team of technicians and physicians from among the prisoners, to develop machines utilizing the energy you have discovered, or you will be hanged.'

Schauberger understandably chose the first (insisting that his helpers must no longer be regarded as prisoners) and so an intensive period of study began. After the S.S. college, where the research was taking place, was bombed, Schauburger and his team were transferred to Leonstein, near Linz. The project they initiated there was a 'flying saucer' powered by a 'trout turbine'. Schauburger was clear about the principle of construction.

If water or air is rotated into a twisting form of oscillation known as 'colloidal', a build up of energy results, which, with immense power, can cause levitation. This form of movement is able to carry with it its own means of power generation. This principle leads logically to its application in the design of the ideal airplane or submarine... requiring almost no motive power.

The results of the research were surprising. It was both a success and a failure. Viktor Schauburger later explained this briefly in a letter to the West German defence minister Strauss on 28th February 1956:

I preferred the first alternative, and about a year later, the first 'flying saucer' rose unexpectedly, at the first attempt, to the ceiling, and then was wrecked. A few days later an American group appeared, who seemed to understand what was happening, and seized everything. Then, after a very thorough investigation by a high-ranking officer, I was taken in protective custody, and guarded by no less than six policemen for about six months. An important part of the



apparatus was found in my apartment by the Russians.

In another context he said:

The apparatus functioned at the first attempt... and rose upwards, trailing a blue-green, and then a silver coloured glow.

The Russians blew up Schauberger's apartment when they left it, presumably to prevent anyone else from discovering any information that they had overlooked. Several of his associate scientists had been Russian prisoners of war who subsequently returned to the Soviet Union. When the Russians made their great advance in space rocketry, the story circulated that they had made use of Schauberger's ideas of construction.

It has been said that the 'flying saucer' destroyed in Leonstein had a diameter of 1.5 metres, weighed 135 kilos, and was started by an electric motor of 1/20 horsepower. It had a trout turbine to supply the energy for lift off.

All those who had worked on these tests were interviewed like Schauberger. In 1956 he wrote:

At the end of the war, I was confined for nearly a year by the American forces of occupation because of my knowledge of atomic energy production. After my release, under the threat of re-arrest, I was forbidden to take up again any research in the atomic energy field, although it would have been concerned with new aspects of this technology.

After the signing of the Far East Peace Treaty, I did take up my work once again. Since by the end of the war I had lost all my assets, work proceeded slowly. I refused any foreign financial aids, which is the reason for the delay of the working models, but once the patents were granted, this matter was resolved.

After his release Viktor Schauberger moved to Linz, where his research was constantly hampered by lack of resources. He used to say 'with a penknife and a few pennies in the pocket, one cannot accomplish much'.



The 'Schriever-Habermohl' flying disc developed between 1943 and 1945. In 1944, climbing vertically, it reached a height of 12 km in 3.12 minutes and a horizontal flying speed of 2000 km/h.



The first test-model developed between 1941 and 1942. This had the same flight properties as that in fig. (a), but something was wrong with the controls.

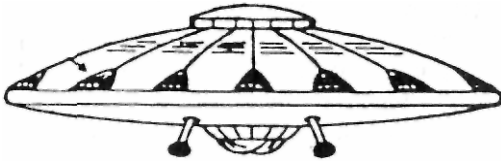

The 'Ballenzo-Schriever-Miethe Disc'. The retractable undercarriage legs terminated in inflatable rubber cushions. It carried a crew of three.

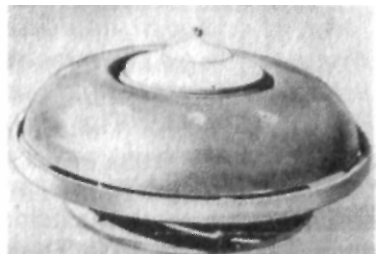

Schauburger's models of 'flying saucers'.

## BIOLOGICAL TECHNIQUES IN AGRICULTURE

### Contemporary Technology's Destruction of Agriculture

After World War II Schauberger concentrated a lot on agricultural problems. Despite his meagre resources he thought it possible to make a contribution in this area. The contemporary destruction of forests and water must ultimately be harmful to man, he realized, particularly in the way it prevents the building up of natural nutrition, a vital process to soil fertility.

The farmers work hand in hand with our foresters. The blood of the earth continuously weakens, and the productivity of the soil decreases. There is fortunately an awareness of the necessity of fertilizing, but now the chemist enters the scene and scatters his salts.

After only a few years there is evidence that soil treated with artificial fertilizer is seen reduced to dross. It is another example of man working against Nature and happily obstructing the last remaining source of nutrition, the capillary system of the soil. The field which had previously given the farmer an abundance of produce had begun to deteriorate. He instinctively sought the solution by using his deep plough, thus destroying the system of capillaries in the soil. Now the same thing is happening in our forests. Externally everything seems to ripen and thrive, but it is only a facade. The ripening has emerged from putrid ground; the fruits of decay are cancer.

The strength of the corn is weakened, the meadows are covered in moss, the fields are bare of produce - only work and its cost increase. The end is the loss of the clod of earth, the loss of the homestead.

Schauberger knew what he was talking about. He had lived his whole life amongst farmers on the Alpine slopes and in the valleys in Steiermark and Salzburg. He had seen the conditions of their fields and harvests when the prime forests still existed, and the watercourses remained undisturbed. He had later seen what happened after the onset of forest clearance and the consequent degradation of water. He had carefully studied the old farmers' traditional methods and the results they achieved, and then compared these with the new, so-called rational methods of agriculture that had since spread. The comparison did not flatter the modern methods.

For Schauburger the growth process revolves around a sequence of the charging and discharging of energy. Growth he saw as a balancing of the charges, where, amongst other things, the difference of electrical voltage between the atmosphere and the earth was of fundamental importance. If the charge is to be utilized, however, there must be some form of insulation between the two voltage polarities, or else there is only a wasteful short circuit.<sup>22</sup> Schauburger talks a lot about this insulation, this 'skin' that the earth must have around itself. He described its form, how it is being diminished, and how it can be built up again. One golden rule is that the soil must not be stripped bare; it must always have a covering of vegetation or something else.<sup>23</sup>

The quality of water is also crucially important for the growth process. If the forest the source of good water, is ruined, and the watercourses become dirty relics, then the water can no longer build up the important ground voltage. This encourages the formation of pathogens, disease producing parasitic bacteria that lower the quality of the produce that can still be grown.

### Old Farming Traditions Were Friendly to Life

Schauberger often reminded himself of traditional methods used by the old farmers to increase their harvests. For example, at certain times they would add finely-chopped coniferous branches to the soil, adding valuable trace elements without realizing it

The supposedly simple farmers, who include the high forest farmers of Muhlviertel [a region in the Bavarian

forests] grew, for about forty years, the best potatoes and the heaviest oats. If you asked a farmer how this was achieved he would, with an artful smile, promptly reply that you must always remain true to the very ancient beliefs of the land and avoid any kind of instruction, if you want to be fortunate in agriculture.

Schauberger liked to mix with the old farmers, and they with him. In an essay, *Natural Farming*, he tells us in detail of a visit he made to such an old farmer, whom the whole community considered eccentric, even though none of his neighbours could boast such good harvests.

This farmer ploughed in a different way. He also harrowed differently and sowed at times other than those of other farmers. His method of treating crops was also different. In short, he carried out each and every farm process in a unique way. He never went to church; this he would have taken particularly amiss. He was never seen drinking beer with others. Nobody asked him for advice and he never tolerated any argument from his employees. Those who did not immediately obey him could immediately pack up their goods and chattels and go. Despite this attitude it was seldom that he lost an employee. It was only with his grown son, who attended an agricultural college, and who always thought he knew better, that there was any tension.

So it happened one day, as darkness was setting in, I came to the farmer's house. I wanted to have a short chat with him. In the courtyard I met the somewhat unsympathetic son and enquired after his father. 'He is in the back of the house - the old one', he answered with an unfriendly gesture. 'Shout loud enough and he will come'. I went where he pointed, across the threshing floor, and eventually found the old farmer. He was standing in front of a wooden barrel as large as three or four buckets, singing a quaint song. At the same time, he was stirring the contents of the barrel with a large wooden spoon. It was not really a song he was singing, but rather a musical scale rich in tone, ranging from falsetto to double bass. This he did as he bent over the barrel, singing loudly down into it. As he went up the scale, so he rotated the spoon in an anti-clockwise motion. When his voice deepened, so he changed the direction of the

rotation of the spoon.<sup>47</sup> I thought to myself that there must be a reason for all this. The farmer did not hear me coming, and after I had watched him for a considerable time, I was curious as to what he was stirring. Unnoticed, I came up to the barrel and glanced inside; there was nothing there except clear water. Eventually the old man noticed me, nodded in reply to my greeting and continued to stir without pause.

My glance alternated between the farmer and the contents of the barrel. With a flick of his hand, he would throw bits of loamy soil into the barrel as he continued to stir the liquid first to the right and then to the left. At the same time he sang quite loudly and not altogether pleasantly into the open container.

'Well', I thought, 'Nothing lasts forever'. At last the old man took the giant spoon - it really could be described as a small oar - out of the barrel and muttered, 'So, it's ready for fermenting.'

I nodded as if to indicate that everything was perfectly clear to me. I nodded again, when the farmer asked me whether I had a thirst and would like a grog of fresh apple juice. So, after the old man had carefully wiped his wet hands on his apron, we went into the house. While he fetched the cool apple juice from the cellar, I walked into the best room. 'Now let it taste good'. With these words he slid the blue-flowered tankard of juice across to me, inviting me to join him.

'Now do you think, as others do, that I am mad?' asked the farmer. 'You know what you want', I replied. In the course of our conversation I gradually referred to the series of actions he had just performed and I had noted. Clay mixed in cool water with air-evacuated carbonic acid, which



The heart of a cockchafer, a rhythmical sequence of chambers (after Schmeil).

is then stirred in the right way, will take on a neutral voltage (similar to the effect of well-kneaded loam wrapped in aluminum sheeting).

This neutrally charged water was then sprinkled over newly harrowed and sown fields. The harrow had wooden and not iron teeth. The water eventually evaporated leaving exceedingly fine crystals which carried a negative charge. These crystals attracted rays from all directions and then gave them out again.<sup>24</sup>

Between the geosphere and the atmosphere, a fine membrane, violet in colour, builds up. This skin, acting like a filter, allows rays of the highest value to enter and leave the earth. The down-to-earth farmer called this filter 'the virgin hymen'<sup>48</sup> Such a valuable diffusion effect could be obtained, that during the driest part of the year, the soil remained cool and moist. By this means, the seed zone between the geosphere and the atmosphere remains at a practically constant temperature of +4°C. At this temperature the crop structure is at its highest potential, while at the same time fructification is relatively passive.<sup>25</sup> As a result of this simple caring for the surface breathing of the earth, an increase in crops of some 30% was obtained compared with where it was not carried out. In the old days this natural breathing action was called 'clay singing'.

Another old tradition was to plough furrows at right angles to the path of the sun- so-called 'sun ploughing'.<sup>26</sup> Schauberger considered that the modern farmer did not care enough about traditions. For him, time is money - he ploughs the largest area in the shortest time. The old-time farmer thought differently. He was closer to Nature, and relative time and method had for him always been constructive conceptions; he continued to trust, even in secret if necessary, in the old ways.

The special lay-out of the old granary and the special shovelling action used for the grain, first in one direction and then in another with a wooden shovel of defined dimensions as practiced by the old farmer had a deep significance.

Schauberger discovered that there was a factual basis for much of what the old farmer said. For example, it was shown that fields used for cattle grazing, that had the grass cut by

hand scythes, were much more fertile and rich in different grass species and especially health-giving herbs, than when the cutting had been done with machines. Furthermore, it was shown to be especially beneficial to cut grass with hand scythes sharpened by hammering, instead of being ground in the normal way. The old farmers of Estonia used this method of sharpening. Schauberger thought that if the hammering were done against the support of hardwood timber, instead of, for example, iron, the mechanical charges generated by the hammering formed an energy within the scythe that was released during harvesting, giving the roots and plants energy for growth. It was important not to allow the hammered scythe to lie out in the sun, otherwise the charge would dissipate and it would go 'flat'.

The positive influence on growth occurring during cattle grazing, or with the use of the hand scythe, was due to the fact that the plants were torn or cut off in a way that closed the cut surface of the remaining stalk. A cutting machine, however, damaged the stalk so that the cut remained open for a long time, and it was through this open wound that the growth energy escaped uselessly into the atmosphere. The same theme lay behind the old forester's opinion, with which Schauberger agreed - that it was better for a forest if the trees were felled with an axe rather than a saw. The latter left the stumps exposed and damaged.

### Iron or Copper Equipment in Farming

In the 1930s Schauberger was invited by King Boris of Bulgaria to examine the reasons for the great decline in that country's farming production. During his trip through the countryside he noticed that in the areas populated by the Turks, the harvests were more plentiful than elsewhere. It was here that the old wooden plough was still used. The rest of the country had replaced these with modern iron ploughs imported from Germany as part of a general modernizing of Bulgarian agriculture. The first steam ploughs had also been introduced. Schauberger drew the logical conclusion that the reduced cropping was a consequence of the introduction of iron ploughs, but it was not until later that he developed his theory of the detrimental effect of iron machinery on agriculture. His work with water jets gave him a new perspective on the



problem (see p. 89). It was shown that if a small amount of rust was added to the water in these experiments, no charge developed; the water became 'empty'. He abstracted this finding to the use of iron ploughs and thought their effect on harvest yields must relate to this. When the iron plough moves through the soil, it becomes warm, and the disturbed soil is covered with a fine dust of iron particles that quickly rust. He had previously noticed that iron-rich ground was dry, and that the turbines in power stations 'discharged' water.

The conclusion of all these observations was that iron had a detrimental effect on the water characteristics within the soil; it expelled the water and 'drained' it of its power. When the steam plough, and later the tractor plough, were introduced, the situation worsened as a result of the increased speed with which the blades moved through the soil. Walter Schauberger has said that water disappears from fields that have been ploughed in this way, for straightforward physical reasons; the iron plough's rapid passage through the soil cuts through the fields magnetic lines of energy, causing an electrical current to occur in the same way that a coil in an electric generator rotates in a magnetic field. This, in turn, leads to an electrolysis in the soil which separates the water into oxygen and hydrogen. The electrolysis also damages the microscopic life in the soil and this leads to an even higher temperature occurring in addition to the iron blades' friction with the soil. It is especially with iron that these phenomena occur. With ploughs of wood, copper and other so-called 'biologically magnetic' materials, the soil's magnetic field is not disturbed.

The conclusion that Schauberger drew from these observations, was that another material than iron should be used for farming equipment. His attention focused on copper. Copper-rich soils retained their ground moisture well, and so he began to experiment with copper ploughs as well as other equipment made from copper. To begin with he merely covered an iron plough's cutting surface with copper sheeting and made tests with this. The tests took place under controlled conditions, dividing the field up into segments, some of which were ploughed with the prevailing iron machinery and some with the adapted copper machinery. The results proved very favourable to the copper, which showed a 17-35 per cent increase in harvest. A large firm, Farmleiten - Gut Heuberg, near Salzburg, showed an increase of 50 per cent On a hill

farm outside Kitzbühl tests showed an increase in the potato crop of 12.5 times the quantity sown. Throughout there was an increase in quantity, but also a marked increase in quality. The baking potential<sup>50</sup> of corn was increased, and potatoes were not attacked by the Colorado beetle, though neighbouring potato fields ploughed in the more usual way were still attacked, and the nitrogen requirements of the soil were reduced. During 1951-52 controlled tests with the copper plough were made by the Farming Chemical Test Station in Linz. The tests concerned the cultivation of oats, wheat, kohlrabbi and onions. Certain sections were worked only with iron machinery, others with iron machinery and added copper sulphate, and a third area with only copper machinery. In certain tests the copper sulphate was exchanged with pure copper dust. A significant increase was observed in these tests also.<sup>27</sup>

Rumours of these successes spread to farmers around Salzburg where many of the tests had taken place, and they started to call the copper-wonder 'the golden plough'. It was manufactured in large quantities but soon considerable opposition arose from an unexpected quarter.

In 1948 Viktor Schauburger had signed a contract with a company in Salzburg for the production of a large number of ploughs. Then suddenly one day he was visited by a high official from Salzburg's treasury office. The latter arrived in an elegant car, and the following ensued: the treasury director: 'There has been a rumour that the Salzburg town corporation has carried out successful tests with your ploughs, and, naturally, this is of interest. But now I must ask you face to face - what is it worth to me, if I support you?'

Schauburger said: 'I don't understand what you mean. You are from the treasury, you have nothing to do with support. I have paid my fees for the test and everything is complete.'

The Treasury director went on: 'I must make myself clear. The fact is, I have an agreement with the nitrogen industry whereby if I can stimulate the farmers to use more nitrogen than usual I receive a royalty for each sack being sold. If now the farmers were to change to the copper plough the demand would permanently diminish, and thus I need royalties from your ploughs as compensation. Can't we come to an understanding as old friends and make a good deal for us both?'

Schauburger replied furiously: 'I have only one thing to say

to you - you are a greedy rascal - a thing I should have understood at once - when as a representative of the people you drive around in a luxury car.'

It was after this exchange that there was a surprise termination of the contract from the company that was to have provided the ploughs. Representatives from the local agricultural society also started to warn farmers against using the copper plough as it could cause over-production which would give lower prices. Thereby their production and use were totally halted. In 1950, Schauberger, together with engineer Rosenberger, however, obtained a patent on a method of coating the active surfaces of farm machinery with copper.<sup>28</sup>

### The Spiral Plough

Schauberger also wondered if the conventional plough even functioned biologically correctly. Here, also, his ideas on the

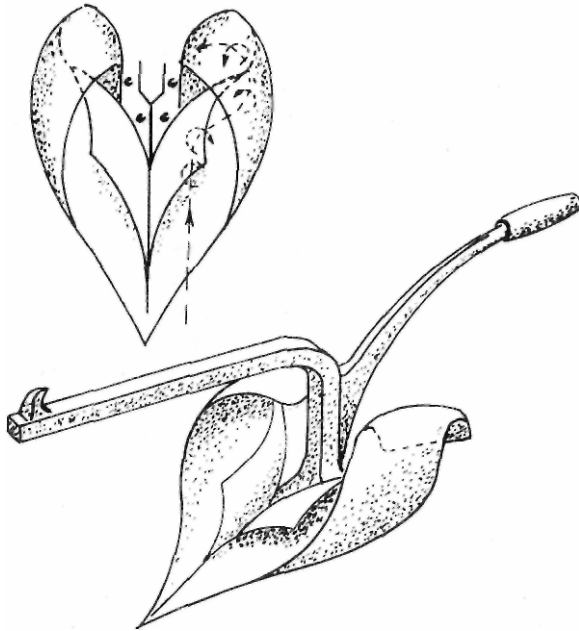

The spiral plough should duplicate the work of the mole. The dashed line with an arrow shows the movement of soil through the plough.

importance of natural motion were relevant. It occurred to him that soil should be directed into a centripetal motion when ploughed, and mis led him to develop the 'spiral plough', though this never passed the model stage. Its principle of turning the soil was much the same as that used by the burrowing mole. Because of the shape of the cutting and turning blades, the plough should work the soil with almost no resistance, rendering it free from the pressure and friction and consequent heating that accompany use of the normal plough. The spiral plough was not meant to be used for deep ploughing, but only for the treatment of the surface soil. Schauberger was against deep ploughing and sided with the biologically and ecologically-influenced farming community, which thought deep ploughing only disturbed the micro-organisms' important work and upset the natural levelling of the mouldy top soil.<sup>23</sup>

### The Repulsator and 'Noble' Compost

To Schauberger, as we have seen, the growth process was above all a question of energy. He understood growth as a balancing process between geospheric energy and atmospheric energy. He saw the plant as the end product of energies meeting each other above the insulation layer at surface level. Thus all his attempts to encourage growth were devoted to increasing the soil's energy, and to encouraging the build-up and preservation of the insulation 'skin'. He rejected all activity that removed energy from the ground and damaged the insulation. Consequently he was, for example, a vigorous opponent of Thomas-phosphate,<sup>51</sup> a product of the blast furnace which drains the soil of strength. When it is introduced to the soil it tried to compensate for this by attracting new energy. One way to build up the ground energy is by adding stable manure, compost, micro-nutritional elements, and catalysts to the soil, which should in turn be well covered and protected from the direct rays of the sun. Also, iron tools are to be avoided. It is of course important that the whole landscape is healthy, with forests and water living natural lives, as it is from these sources that the ground energy originates. Schauberger stressed, on the other hand, that the ground's energy could be increased by using 'biological' machinery. The 'repulsator', for example, could be used to produce specially charged

water. This special 'power water' was to be spread over fields at a maximum temperature of  $+7^{\circ}\text{C}$ . Alternatively, the thick insulation consisting of some hydrocarbon material built up around the respulsator could be turned into the ground to be treated. When functioning, the machine produced a 'bio-radiation', raying out horizontally into the ground, thus assisting in building up the 'ground charge'. With this and other apparatus, Schauberger thought it might be possible to transform deserts into fertile regions within a short time.

He distrusted the ability of prevailing science to deal with the earth's fertility - a malaise that this science has helped to create:

In any case, it is astonishing to note how modern science acts in opposition to that which is presented to man in unspoiled nature. It tends, in fact, to oppose Nature as it was before man violated it. It is hardly surprising that food production is at best only barely sufficient for immediate needs; there should be great surpluses. Today's science thinks so primitively; one could say an octave too low. It concerns itself with materialistic rather than with energy-producing fields. For this reason, it must shoulder most of the blame for the conditions prevailing today. Probably, this path of development was necessary, otherwise how would confused man recognise the true interrelationship between man and Nature? It is now vital to demonstrate with practical examples how it is possible to create a close-to-Nature land culture before the whole of mankind is totally stripped of human feeling.

Viktor Schauberger gives much practical advice in his writings on what he calls 'close-to-Nature farming'. He describes a home-made respulsator that anyone can make; you take a vessel of wood, unbaked clay or glass, and it should be preferably egg-shaped, (nails or nail bands must not be incorporated in the wooden vessel). The vessel should be about two metres high, and should be buried in a shady place, so that the opening at the top is level with the ground, and the egg shape tapers downwards. Water of the best quality is poured in, and a few handfuls of powdered animal horn (or other organic materials such as bone, feather dust, hen droppings or cow manure, etc.) is added, and finally some

copper and zinc particles that have previously been hammered against, for example, a piece of oak. The solution is then stirred with a wooden ladle impregnated with thin copper and silver plates (N.B. no iron nails!), first slowly from the left, inwards from the edge, so a swirl is created, and then this is repeated from the right. Then a tightly fitting wooden lid (no iron nails!) covers the vessel, but this has a small hole of 1 cm diameter, which is covered with a piece of linen. The vessel should be left for two to three weeks, and will then radiate a horizontal energy into the surrounding ground. After this time the water is used for irrigation, supplying a powerful energy to the plants. The vessel can even be filled with a liquid manure solution, in which case the vessel must taper upwards, and the solution be left for six weeks before application.<sup>29</sup>

The egg shape, which Schauberger thought to be an especially valuable and developed form has a special function. The shape will encourage the liquid to move in a cycloid spiral motion, initiated and maintained by changes in temperature.

Schauberger gives us the recipe for one of his 'noble' composts, which he considered especially rich:

At the base of a tree, preferably a fruit tree, which has a wide crown and deep roots, a pit in the form of a half circle is dug on the shady side and where no damage to the roots can occur. The tree trunk is protected with paper, bark etc. from direct contact with the rotting earth, which is caused by the inevitable incidence of light impinging on this earth. Then a two span layer (40-50cm) of freshly sown grass with clippings of all kinds, such as potato and fruit peelings in as fresh and air-dry condition as possible is mixed with a variety of fruit stalks ...

This well mixed heap is then provided with ologodynamic (breakdown excitation) and catalytic (build-up excitation) copper and zinc dust. The best results can be obtained by filing pieces of zinc and copper and allowing the dust (only a very small amount is required) to spread widely on the ground as trace elements ...

Some salt and a limited amount of cane sugar are added, after which the whole mixture is placed in the pit and a layer of earth placed on top and made waterproof to prevent rain water from seeping in ...

This heap of compost is then left for a time until a further

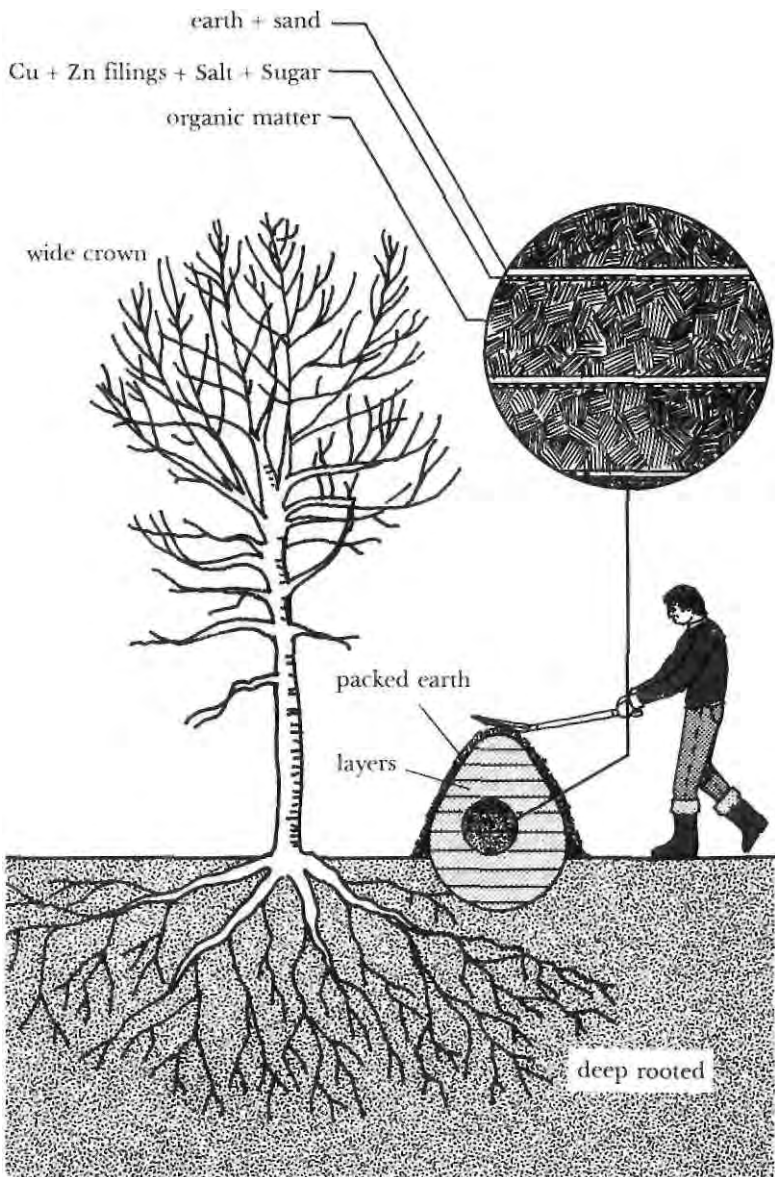

'Noble' Compost Heap

amount of fresh waste (clippings etc.) again mixed with fresh grass, is added. After this, trample the heap and cover it with a 10cm layer of earth mixed with silica sand (preferably fine river bed sand). Then cover the whole layer against the rain (with straw, hay etc). Layer upon layer can be added reducing the radius so that the finished heap is egg-shaped. On the top, a layer of fallen leaves, lightly placed, forms an air lock and the entire heap is padded down smoothly with the broad side of a shovel, so that the rain drops falling from the trees will only dampen but not penetrate the surface of the heap. Under these conditions, the all-important surface tension can build up.

Schauberger then describes what happens in the heap: it attracts the soil's micro-organisms which flourish there throughout the summer. Then the worms die and in later winter they decay and change into high-grade molecular fats or the soil's oils. When it becomes +4°C the heap flowers, and after two or three weeks it is ready, (if it was laid down the previous early summer). The compost soil has now completely changed with base elements and energy concentrations from earlier lifeforms. It can be spread over the ground with a spade of copper, bronze, wood or galvanised metal. Only a thin layer, about 1/2 cm, needs to be used, and this should immediately be mixed into the soil with tools that also must not be made of iron. Then the soil is ready for sowing.

No vermin shows itself on this earth. Hardly a weed is to be seen. The 30 per cent increase in harvest yield and the significantly higher quality of the produce is maintained and will continue to be maintained so long as this particular compost is applied.

Schauberger, as previously mentioned, condemned all artificial fertilizing, but especially that which has been subject to fire, or warmth of any kind. It then becomes, he says, to greater or lesser extent, of one polarity, and therefore attracts only the nutritive 'mother elements' in the soil. Although this may increase the harvest in amount, the soil is damaged through the disruption of its life processes, and, consequently, products from such soil will be harmful in the long run to the human body, and are a constant drain on the physical and



spiritual energies of the person eating them.

A free people can only arise from a free earth. A people who violate Mother Earth have no right to own a home... Man is what he eats and he remains an animal so long as the build-up of products of quality is stifled. So a cycle is completed: infected water cannot produce healthy food. Infested water and poisoned nutrients cannot produce healthy blood. One is only superficially aware that the spiritual functions have not developed and that the decreasing quality of grain production has an effect on future generations. The farmer of today treats Mother Earth in a worse manner than a whore. Moreover, he prays to a god, whom he believes is up above but in reality is under his feet. The modern farmer violates the earth, which reacts by opposing her. The god he strips yearly the skin of the earth and applies poison as artificial manure and then wonders why this wretched process demands more work and yet yields less and less each year.

The old farmer was, for the clod of earth, both its priest and doctor. The modern farmer, on the other hand, is personally and collectively harassed politically and is concerned about government subsidies. He believes that he can, to a massive extent, defy Nature.

The modern doctor is similarly quite helpless in combating the increasing spread of cancer. He is unable to stimulate the internal strength of the body, which has been weakened through digesting foodstuffs produced by artificial fertilisers. In certain glands, symptoms of putrefaction can be detected.

In the same way, the modern impatient farmer driving his wretched machine in the fields, is required to put in more work with a corresponding reduction in the rate of yield, which is governed internally by the earth (not by what is added).

The whole decline of agriculture, our most important source of nutrition, could, according to Schauburger, be halted if we were humbly to recognise Nature's order, and copy its methods. We must acknowledge that growth does not depend on chemical and mechanical inputs, but on the balance of energy relationships of soil and water.

## SCHAUBERGER'S CRITICISM OF SCIENCE AND SOCIETY

### Death Technology and the False Culture

With increasing bitterness, Schauberger realized that his attempts to alert 'the establishment' to the breakdown of the ecological order were achieving little result. Nor had he had any success in his attempts to get scientists to stop their technology of mass suicide. His only hope was that one day human beings generally would wake up and force a change.

The longing for Nature, strong, silent and healthy, is the vital phenomenon of our time, and is the counterbalance to an inorganic civilisation, which we mistakenly describe as culture. The present civilisation is the work of man, who has built up in his own autocratic way a superficial world which threatens to destroy him. He should be master of the world, but due to his behaviour and activities, he has destroyed Nature's unity and order. There is a growing conviction, as we stand confronted by our own creations, that they will destroy us; we cannot see what direction to take towards a better life, as each step seems to lead inexorably towards a worse one. The only way left is to return to Nature. Man is created from Nature, and is therefore dependent on Nature's laws. Man has created his own pseudo-culture in which, as time has passed, Nature's influence has become meaningless and irrelevant, because of the enormous power of the technical resources in man's power, and which threaten to usurp the natural forces. This technical monster has already harmed Nature's vital processes. Man is only a minute grain, a micro-organism, in the totality of Nature, who through his own endeavours has upset the balance of life in

a remarkably short space of time, and threatens the demise of the higher quality life on this planet

The power behind this is our intellect and the senseless progress of technology and lawless culture it has created, which has brought about the interruption of the natural flow of water in the earth. All that has been created by the mechanistic civilisation will finally collapse as the tempo of change increases. It will not be just a temporary crisis, but will lead to a permanent break-up of culture built like a tower on sand. Unfortunately what was true in the culture will also be swept away.

### Biological and Spiritual Breakdown or a New Revolution

Schauberger's hopes lay with the young. In the midst of his despair he thought he could discern some indication that the youth might refuse to support technological development

When one sees the youth today refusing to take the broad road to destruction, there is hope for mankind. But this is not enough. Young people will only start acting when the cause of our present chaos has been uncovered. This will not solve our problems, as the co-called experts will do all they can to protect their way of life and their position in society. However, even this conservatism could be overcome if it were possible to localise the problems, so that one could be disentangled from another and tackled separately. There is very strong evidence that misunderstandings of our environment originating centuries ago have contributed to the spread of illness today. This has further been compounded by incorrect methods of treatment which have led to serious cultural, technical and economic failures. No area of public life can escape, which means that almost every 'expert' in all walks of life will feel threatened. So no co-operation for sensible change can be expected from any experts. Their opposition will, in fact demonstrate our priorities.

Now the time has come for every single person to ponder on the world's situation. It is enough for everyone to start thinking about the state of our water.

Everyone who is unfortunate enough not to be able to get a fresh cool drink from a natural spring should consider where his water comes from, how it is transported and through what artificial means it is made drinkable.

Those who year after year are forced to drink only sterilized water should, for once, consider what effect such chemically adulterated water has on their organisms. Water which has been sterilized and adulterated leads inevitably to bodily decline. It also causes spiritual debilitation and a systematic degeneration of the very foundations of manhood.

Many people comfort themselves by saying 'It isn't that bad'. Soon technology and science will solve the problems. Such reasoning is, however, symptomatic of how far the decline has already reached.

The reason why man's cultural and economic decline is punctuated by transitory crises is due to his spiritual decay, which inevitably follows each stage of bodily decline. Civilized man, despite his supposedly high technical culture, has reached such depravity, that he is no longer able to recognise this physical and moral decline as being in fact a continuous and progressive cultural decline.

Those who can see the mistakes of the past must not be seduced by the comforts of the present materialistic life; the only way to find the solution to our problems is to expose, for all our worth, the attitudes which have been responsible for our present predicament

The best way is to shout from the rooftops when we hear the wrong counsel being given. All members of society, the poor and the rich, the high and the low, must be made aware of doubtful claims and misrepresentations, which are becoming more and more evident. A new attitude about what is important in our society should then begin to pervade the majority of people, so that the will of the people will enforce a change which can never be reversed.

Those who, because of their jobs, are forced to earn their bread in the large towns, should realise that as bread and also water become ever scarcer, they also become more costly and of a lower quality. While it may be unpopular to warn of impending danger, the attempt should be made,

whether it is a case of not knowing or not wishing to know.

Schauberger saw the catastrophe approaching - complete chaos as the result of the break-up of the existing technological and social structures. But after this he glimpsed a new age, where man has finally learned to understand the need to live in relationship with Nature, and so,

some comfort can be derived from today's unacceptable activities. The time will come when man will think back and say to himself, 'They were idiots; they seriously believed they could force upon the world a false technique, to create a culture.'

Schauberger is clear about the path to be taken by these future generations:

Mankind in the future will be in complete control of the material of the world and will be able to guide its progress towards better quality. He will become the supreme servant and at the same time the lord of Nature. Marvellous harvests will provide him with food of the highest quality and also he will enjoy absolute freedom of movement over land, water and air ...

Consequently, life's battle, class war, the fight for existence and, above all, every war for food and raw materials, will cease. There will also be fundamental changes in medical curative methods. What Paracelsus anticipated will become a reality: a certain element will be discovered which will nip the germ of every illness in the bud. Man will become a stranger to illness and thus will be happy with life. There will be ample space for everyone who takes part in the whole process of development in the use of raw materials.

Everything emerged from the water. Water, therefore, is the raw material of every culture or the basis of every bodily and spiritual development. The discovery of the secrets of water makes nonsense of every kind of speculation leading to war, hate, envy, intolerance and discord. It would mean the end of monopoly, the end of all forms of domination and the recognition of individualism in its most complete form.

By way of naturally occurring oxidation (cold com-

bustion), machine power can be generated, and substances produced in great variety, which in turn can stimulate growth, merely from the air and from water.

It is clear how man can become the master as well as the servant of all creation. Yet this possibility is held on a knife edge, and one mistake could plunge him into the abyss. The man who understands creative transformation is like a god. The one who manipulates this for his own ends is a servant of the devil, who can destroy the whole world.

## THE FINAL YEARS

### Experiments at the Technical College in Stuttgart

In 1952 the federal university concerned with the management of water resources asked Professor Franz Popel of the college to undertake certain experiments to test Viktor Schaubberger's theories about water. When Walter and Viktor Schaubberger came to participate in the experiments, Professor Popel was unwilling to go through with them. He told minister Kumpf that Schaubberger's reasoning went against the laws of mechanics, and that he considered the tests could not provide any technically useful results. Kumpf agreed with Professor Popel, but he still wanted the experiments carried out, so that Schaubberger's fantasies would finally be discredited.

The experiments got under way, and it was the characteristics of water motion that were first studied. Schaubberger started by asking Popel if he had ever wondered what happened to water when it left the bath tub. The formation of a funnel shaped spiral could be seen as it drained out - but what happened after that? A faint glimmer of interest appeared in Popel's eyes, and they constructed a test model with which it was hoped to investigate straight and spiral pipes in order to determine:

- 1) Can water that flows through a pipe be encouraged into 'a manifold inward flowing motion?'
- 2) Does the shape of the pipe have any bearing on the development of such a motion?
- 3) Does the material of the pipe have a bearing on the result?
- 4) Do molecular structural changes occur in the water during such inward flowing motion?

5) Can such an inward flowing motion be used to prevent pipes from crusting up?

The test model that was built for this experiment consisted of a large container shaped like half an egg. To its bottom was attached a glass pipe several metres long. Into the vessel was placed a hose wound in a spiral, the inside of which was perforated with holes, so that the water flowing out through them created a strong swishing motion within the container. If the water was coloured it could be easily seen that the swirl continued down through the glass pipe, and that the intensity of the colour increased towards the centre of the axis of flow. Professor Popel now began to be seriously interested, and lowered a number of small triangles hung on strings, so that a long prism was formed to enable more exact studies to be made. It was observed that this prism revolved in the same way as the spiral.

Next they wanted to find out how substances that were not water-absorbing would behave in this swirl. A measure of sand and fine iron filings were, therefore, poured into the vessel container.

To their great surprise, Popel and his assistants found that these additives were not forced out against the wall of the pipe, but were instead wound together within the axis of the spiral motion and there they seemed to coagulate into egg-shaped forms. These they gathered in a container at the outlet. If one of these 'eggs' was broken apart, there was no moisture to be found within it

A special control regulated the water flow and with the right 'tuning' a motionless wave of egg-shaped curves formed inside the pipe, and like a string of pearls could move up and down, according to the pitch of tuning.<sup>30</sup> It was observed that a triple motion occurred in the pipe. There was a spiral motion within a spiral motion and a motion up and down in long profile. There was also a strange light phenomenon around the pipe.

When the tests were completed, Popel was no longer negative, and enthusiastically wished to continue. He said that now he understood that new factors must apply when a spiral pipe is used. But he was still taken aback at the pipe which Viktor Schauburger then introduced - it was based on the shape of the Kudu antelope's horn. At first he thought it mad to use an 'outlandish shape', but later he agreed.



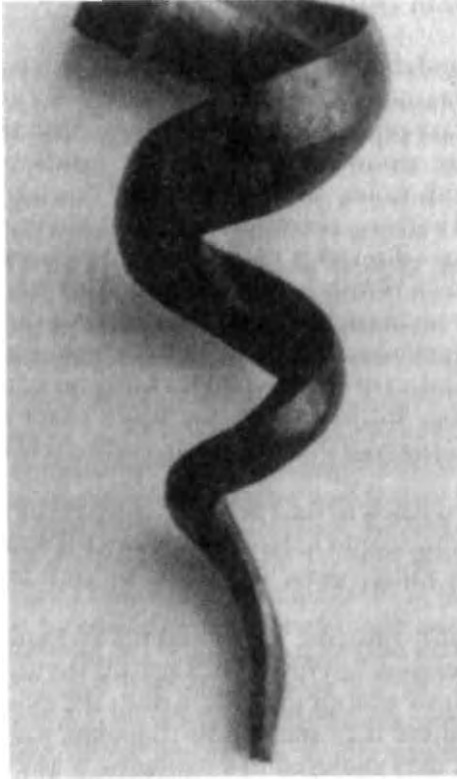

The spiral above is a copy from the horn of a Kudu antelope which was used in experiments at the Technical College in Stuttgart.

They now made flow tests with a straight test pipe of glass, a straight copper pipe, and finally a strange spiral pipe (which fairly well represented Schauberger's ideas about the cycloid spiral space curve).

The results started Popel and his associates. The glass pipe which had completely smooth walls caused greater resistance to water than the copper pipe, and it seemed as if the material really influenced the friction. The spiral pipe provided the biggest surprise: with a relatively high rate of flow the resistance dropped towards zero, and then suddenly became a negative value. When the rate of flow was increased there were certain resonance points when friction was at a minimum. In a

straight pipe the resistance increased towards a point when it reached a 'wall' where resistance became greater than the energy required in creating the flow.

The glass pipe was shown to have a greater resistance to the water flow than the copper pipe, and the precise measurements had indicated a tendency to wave building in straight pipes. The water apparently tried to break into wave formation and winding meanders, although it constantly met up with the sides of the pipe, which were not 'in step' with its own natural flow. In the spiral pipe, however, the water could move as it wanted, and so resistance was reduced. Professor Popel wrote this about the special pipe: 'It seems that in this pipe the pillar of water releases itself from the pipe walls and, freely swinging, rushes forth through the pipe.'<sup>31</sup>

Thus, Viktor Schaubberger's theories of water motion had been confirmed even in a laboratory where the natural conditions for natural motion could only be roughly duplicated.

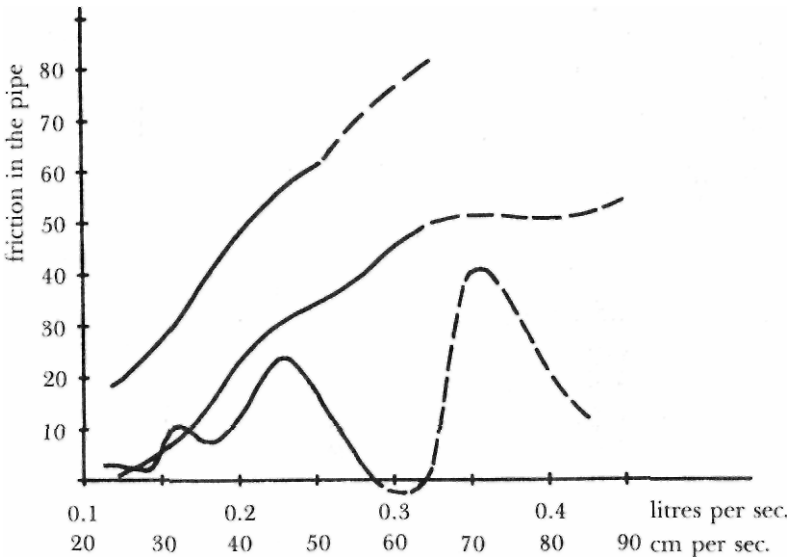

Graph of the tests in Stuttgart The upper curve shows friction in a straight glass pipe; the middle curve, in a straight copper pipe; and the bottom curve, the spiral-wound copper pipe. The solid lines show measured values, and the broken lines the estimated values.

### Fantasy or Reality?

In 1956 the Austrian author and occultist Leopold Brandstatter wrote the book *Implosion* instead of *Explosion*. The author wanted, through this book, to publicize the name of Viktor Schauberger to a wider public, and to generate opinion against the increasing nuclear danger. The book attempted to show that there was already an alternative, which did not threaten life, to the so-called 'peaceful' power. With the best intentions, Brandstatter's speculative approach clearly coloured the content of his book. He had reworked his long interviews with Viktor Schauberger to fit his understanding of the meaning of Schauberger's discoveries. The result was a mixture of facts and fantasy. The critical eye was put off by the occult language and the fantastic descriptions of implosion power. The less critical believed that a huge technological revolution had already begun. In Germany, especially, there was great interest in Schauberger and implosion research. Some periodicals took an ideal stance, and, critical of the contemporary situation, suggested grandiose plans should be made to form an international Viktor Schauberger movement. Some writers implied that Schauberger's implosion machine was ready for mass production. As soon as enough capital had been generated, production would start. All the world's power stations and nuclear plants could be shut down, great wide sweeping reforms could begin and the beginning of a new millenium society was on the horizon. Guarantees should be obtained from all Governments in the world to ensure that implosion power was not to be used for military purposes. Viktor Schauberger was kindly enough disposed towards all this publicity, but he expressed his dislike of Brandstatter's misuse of the interviews. He was enthusiastic that his message should reach the masses all over the world, but he was also wary of getting caught up in big plans. He declined to support the planned movement in his name, and instead he strove for the establishment of an international research institute in Austria for the continuation of research into implosion. He had the hindsight of some bitter experiences in his life. People had appeared to want to support him, only to deceive him. He also feared that the centres of power he most distrusted, the energy and armament monopolies, would exploit his discoveries behind his back.

His health was also suspect. The effort and stress of the war, his arduous research and his shortage of funds had all taken their toll. He had asthma, and periodically suffered from a weak heart. He continued his work despite mounting difficulties. The implosion machine had been a particularly heavy drain, financially and physically. He was greatly troubled at the headlong flight of the world towards catastrophe. He was especially alarmed at the development of nuclear power, which he thought the greatest threat of all. He felt an unavoidable compulsion in some way to help solve the world's energy problems using biotechnological principles to halt the breakdown. But where could he obtain the funds?

#### The American Connection. Viktor Schauburger's Death

This was the situation when two Americans came to visit Schauburger in the winter of 1957/58. The contact had been made through one of the newspapers that worked most energetically for the formation of the international movement for implosion. Schauburger's health had deteriorated during the winter and he occasionally said he thought he had not much longer to live. He became more and more troubled and restless, and he made despairing efforts to solve the problems that were preventing the implosion machine from working properly. What happened then is described by his old friend and associate, Aloys Kokaly, head of the German biotechnical institute.

Last year, while on a lecture tour through South Germany and Austria, I visited Viktor Schauburger in Bad Ischl. He was in company with two Americans. One of these spoke fluent German with a Bavarian accent. Under the circumstances, I was only able to speak a few minutes with Schauburger. Using the phrase 'strictly confidential', Mr Karl Gerscheimer declared that both Schauburgers (Viktor Schauburger and his son) would shortly be flying to America. The 'Schauburger case', he continued, must in all circumstances become also a case for the U.S.A. All technical preparations had already been put in hand appropriate to the vast knowledge which Schauburger was capable of imparting. Unlimited funds would be available. Above all, work must proceed at a pace, because Schau-

berger's visit was limited to three months. Viktor Schauburger spoke of an 'initial help', which, in the three months available, he wished to give.

A German periodical continues the story:

Schauburger and his son were flown to Texas. All that was required in documents, models, equipment and such material was despatched to U.S.A. The months of June, July, August and September in Texas are the most uncomfortable. Was it hoped that Viktor Schauburger would quickly succumb under these conditions - temperature at noon between  $36^{\circ}$  and  $41^{\circ}\text{C}$ ? Schauburger and his son were taken to the solitude of the Texan desert near the Red River. There was no communication with the outside world. The post was censored. The answer to the question as to when would the research work begin was 'Now we have time'. Instruction was given that all findings would be recorded in writing.

The ultimate report with drawings was sent to an expert in atomic technology for analysis. In September this expert, from the state of New York, took part in a three day conference in Texas. His findings were conclusive. He summarized his views: 'The path which Mr Schauburger in his treatise and with his models has followed, is the biotechnical path of the future. What Schauburger proposes and says and asserts is correct In four years, all this will be confirmed.'

When the three months passed Viktor Schauburger insisted on returning to Europe. From the American side, however, the cry was, 'Now that the results achieved have been so outstandingly satisfactory, you and your son must remain here. A matter so revolutionary as this demands a sacrifice! For the next few years you will both be given accommodation in the desert region of Arizona.' The Schauburgers disagreed with such a plan. Eventually Viktor Schauburger was told that he could return home, but with the proviso that he would attend a course in English (he was totally ignorant of the language). He was given thirty minutes to decide. One of the Americans present orally translated this proposition, after a heated argument with both Schauburgers.

For Viktor Schauburger there was no choice. Under duress he agreed to the proposition. His son, Walter Schauburger, was asked to sign a contract, but this he refused to do, because as a visitor to U.S.A. he would be subject to the then current laws.

The agreement included a statement which precluded Viktor Schauburger from passing over any knowledge of his work, past, present and future, except to a 'Mr R.D.' [Robert Donner]. It was made clear to his son that if he did not keep silent in this respect Viktor Schauburger would be silenced by middlemen based in Munich.

In accordance with this 'Texas Agreement', the boss 'Mr R.D.' would have the 'right' to sell the Schauburger case, either wholly or in part, to other groups in transit.

Without any rest Viktor Schauburger and his son returned to Austria after a 19-hour flight Viktor Schauburger was unable psychologically to overcome this ordeal and began to vegetate, as if his brain, his intelligence, his spiritual being, all his thoughts 'belonged' to Mr R.D.

Five days after he returned home, on 25 September 1958, Viktor Schauburger died, in Linz, at the age of 73. Despairingly he repeated over and over again: 'They took everything from me, everything. I don't even own myself.'

## SCHAUBERGER'S HERITAGE

When Viktor Schauberger died, an extraordinary and moving personal crusade ended. All his life he had fought for water, forest and soil, for Nature's wholeness and order, but he had seldom received any acclaim. Attacked, pursued, persecuted, interned, and finally sick and impoverished, he continued to search for a last chance of realizing his dream of giving humanity a new life-building technology. Then he was forced into a nightmare experience which ended his life. He was not even allowed to go in peace. He died in despair that all he had toiled and fought for had now come to nought. It had all been taken away from him by commercial gangsters after they had tricked him with false promises.

How did he see himself before his tragic ending? What had he thought to be his life's task? How had it been possible for him so confidently to criticize technology and science? How could he, who had spent the greater part of his life in the wilderness, presume to have found a better path for humanity, coming forward with discoveries that all the world's scientific establishment had missed?

Let us not make the initial mistake of equating academic qualifications with knowledge. Viktor Schauberger indeed had few qualifications, but this did not mean he was an uneducated man. Both his writings and testimonials from his friends confirm the breadth of his learning. He was well read in history, literature and philosophy. Goethe, to whom he often referred, was his inspiration. Technically, his writings reflect an extensive knowledge of physics, chemistry and hydrology. To this can be added his immense practical experience. Above all, he had been an unusually attentive student of Nature. Perhaps there lies an explanation of his authoritative

behaviour in the following: once when Schauberger was attempting to transform stinking sewage solution into clear spring water, he was visited by some senior and highly educated Austrian Jews who asked where he had obtained his knowledge. They maintained that the process had been known since ancient times in secret Jewish tradition, but it had been lost long ago.

Schauberger answered that nobody had taught him, though he himself had the advantage of inheritance. When asked what he meant by inheritance, he replied, 'Everything is corpuscular, even energy and light waves. Even matter is inert energy. This also applies to blood, which is a materialized power flow that carries energy from past generations through present to future generations. This flow is not broken with the person's death, but is carried further to his successors. However, this energy can be degenerated, for example, by negative technology, so that the thoughts and outlook which have accumulated within a person's being over thousands of years, is lost. It is possible for the person who has the advantage of this gift of inheritance, to summon up from his blood all this reservoir of knowledge.'

This person need not speculate, because he can see the difference between ancient and modern knowledge and can therefore choose between knowledge and science.

Schauberger was himself convinced he had this gift. He knew, he did not need to assemble proof. So he at once saw things in Nature that no-one else could see. He saw what really happened, not what seemed to happen. The difficulties he had were on another level. To translate what he clearly saw into practice, and often with inadequate resources, and to be able to 'materialize', so to speak, the images he himself saw sharply defined and which he never doubted, this was his problem. He knew, and with the inward authority that this gave him he kept up his condemnation of technology, science and politics.

There is something Old Testament-like in his person. He did not choose - he was chosen to spread the word of his revolutionary teachings. People were irritated by his self-confident language, his words of judgement; but they did not understand that he was not 'preaching' for himself. He was a prophet who expressed his anathema to 'death' technology, and to those who degrade life on earth.





Spiral movement in water.

He knew that he was right, and yet vacillated in telling us all he knew. He feared constantly that his discoveries would be misused by people who would work against Nature. He therefore spoke in a cryptic language, giving hints and half explanations. His writings have to be studied for years before one can learn his code... he knew that this invited difficulties, but he could not act in any other way. In a letter to Professor Ude, the Catholic priest and social and economic reformer, asking him for help to save the young from the fate awaiting them, he wrote:

Do you think I would have stood up in public to the extent that I have if I did not have an overwhelming evidence in my hands? Of course not - but I do not aim to cast this profound knowledge to the swine. Capitalists are not idealists. They have all gone wrong, - the capitalists, socialists and communists. And even the scientists are turning back the clock of understanding.

Here lies a deep tragedy. When he could no longer hide his secrets, because the destruction of life's fundamental processes took on more and more alarming dimensions, he was forced to do that which he most feared throughout his life, to throw pearls to the swine.

### Others' Judgements of Viktor Schauberger

The people I have personally met who knew Viktor Schauberger are unanimous in agreeing he was an honest and decent man - natural and hearty, and with a fine sense of humour. If, however, he met with dishonesty or pretence, he became intolerant at once, without regard for the social background of the guilty party.

He thrived in the company of farmers, foresters, and hunters, and the simple life of the forest and country. He did not shy away from social gatherings and always impressed people with his strong personality and dignity.

He had loyal friends and associates, some of whom wrote about him. The first is Professor Werner Zimmermann of Switzerland, a social reformer well known throughout central Europe.

I got to know Viktor Schauberger in Vienna in 1930, when he attended one of my lectures. He talked about his activities, showed me apparatus he had constructed and allowed me to drink of the water he had purified. In September 1935 his first essay on Regulating the Rhine was published in my periodical *Tau*, and was followed by many others until the banning of my periodical by the Hitler Government in 1938 ...

For me it was a great gift to have had the experience of knowing this able researcher and fighter. He was a man who had a close-to-Nature originality. He had piercing eyes, a prominent aquiline nose, an upright bearing and a flowing full beard. How sharp was his power of observation and also his judgement! How to the point were his answers! How heartily he could laugh! New ideas tumbled out, as clear water from a forest spring. To his friends, he was a trusted comrade - he gave to all strength, calmness, confidence, like the mountains amongst which he lived. In a superior way and unafraid, he served the truth and did his duty. In

July 1936 he wrote to me: 'He who lives a hundred years in advance is never surprised with the present.'

A hundred years - what will not happen by the year 2000? The wrong kind of progress will no doubt continue. But, at the same time, forces will emerge, even to be accepted by governments, as a healthy renewal. May they soon contribute towards the realization of Schauberger's vision of the future as of a prophet and what he fought for, during his whole life.

Another was Oswald Hirschfeld, farmer and instructor for South German biological agriculture. He wrote:

It is often said that one's first impression is the most reliable. After reading in the 1930s some of Viktor Schauberger's papers on the necessity of allowing water to flow naturally, I met him personally for the first time, during the summer of 1942. We both took part in a conference, at which he held discussions with scientists of the old school. Even today, after more than thirty years, there is above all a particular memory which persists; his unshakeable self-confidence and inner conviction of the correctness of his theories. He countered all objections with what could be described as an air of superiority and authenticity, which deeply impressed all his colleagues. One had the distinct feeling that here spoke a man, endowed with an inner perception, before whom the elements of Nature and the structure of all life are unveiled, and in their correct order. My many discussions and considerable correspondence with Viktor Schauberger were principally concerned with the natural measures to ensure water economy for agriculture and forestry. In the pursuit of knowledge in this field I had met many people, but never before had I made contact with someone who could throw such clear light on often very complex problems, and who, the more I got to know him, won over my complete trust.

## THE SPREADING SCIENTIFIC SEARCH

Viktor Schauberger's life's work was not buried with him. The thoughts he threw out to the world continue after his death, and inspire other scientists to continue his works.

Soon after Viktor Schauberger's death a working co-operation was established between those who were closest to him. The Biotechnical Academy was formed in Austria under the leadership of Walter Schauberger. In West Germany an association for the advancement of biotechnology (Verein Zur Forderung Der Biotechnik) was started, to be followed by similar associations in Austria, Switzerland and Sweden. Since the beginning of the 1960s many academic courses have been running with a bias towards biotechnological studies. The periodical, *Implosion*, started by Kokaly in 1961, has published four issues a year since then.

At the end of the 1960s Walter Schauberger founded the Pythagoras-Kepler-School (P.K.S.) which is now the centre of research into technological ways of copying Nature.

A group of young academics from this school set up the Gruppe Der Neuen under the leadership of Dr Norbert Harthun, in West Germany in 1969. In association with P. K. S. they produce a periodical *Komische Evolution*, which deals with alternatives and relationships within society and technology.

At the end of the 1950s in Sweden an unofficial science group was formed, that in 1963 became constituted the Swedish Science group for Biological Technology. The group was reformed in 1968 as Biotec, the Scandinavian Institute for Biological Technology, which ceased in 1978. Since 1979 work has continued at the Institute for Ecological Technology.

For nearly two decades of intensive research, Walter Schauberger has followed a path, in part different from that of his



Walter Schauburger.

father. He has attempted within classical physics to try to find confirmation of what his father and himself had discovered. He has often found that Viktor Schauburger's theories are strengthened by the discoveries of famous physicists throughout history, though these discoveries have so far been interpreted in different ways.

Walter Schauburger and a team of scientists are now working through classical scientific models of reality and comparing them with Nature. If they deviate from Nature's reality, then attempts are made to correlate the existing models, and to create new ones that can better exist with Nature. These scientists hope to prove what Viktor Schauburger understood intuitively, namely, that our existing scientific world is false. While Nature is shown to be following a 'centripetal dynamic' direction in an expanding motion towards the beyond, - a transcendental goal-, science has set itself dramatically opposed to this, epitomised by its mechanistic technology, its models, and its theories.

This new research wants now to present a number of facts which have not been seriously studied. These demand a total change of our conventional world understanding, the physical and technological understanding about reality by Newtonian physical mathematics, Euclidean Geometry, and materialistic ideology. These scientists, however, maintain that a revision of this understanding of reality is long overdue, considering discoveries made by such great physicists as Gauss, Lobatchefski, Riemann, Einstein, Planck and others, who unmasked the current static world picture for what it is.

Professor G. Pleskot of Vienna University says this about the work of Walter Schauburger and his team:

Resulting from this research project, a completely unconventional concept is introduced by reconsidering the theoretical basis for all forms of technical development using 'humanizing techniques', which can be defined as being in harmony with, rather than, as occurs at present, in opposition to, the continuous development of mankind.

While present techniques have developed basically from Euclid's geometry and the philosophical concepts of Aristotle-Newton, the ideas of Ing. Schauburger's Pythagoras-Kepler-School have so advanced that the Euclidian principle now represents the transcendental field to which in reality the non-Euclidian principle adhered.

In considering further the intellectual concept of Pythagoras- Kepler- Gauss- Planck- Hasenohrl- Einstein, Schauburger recognized in the law of sound the synthesis of both principles as a basic law of the universe. Through this basic law, the natural combination of the pair of dialectic principles, such as continuity-discontinuity or time-energy is demonstrated.

Schauburger's desire is now to harness the principles of Aristotle- Euclid- Newton, now so greatly revised, to those of Pythagoras, developed over four hundred years since Kepler. This development can also be seen in the fields of technology, economics and politics. In this way, there would be the opportunity to create new schemes, which were both natural in concept and worthwhile for mankind. Thus it is clear that Schauburger's concept is on a grand scale and modern in principle. In my view, it deserves generous support now.

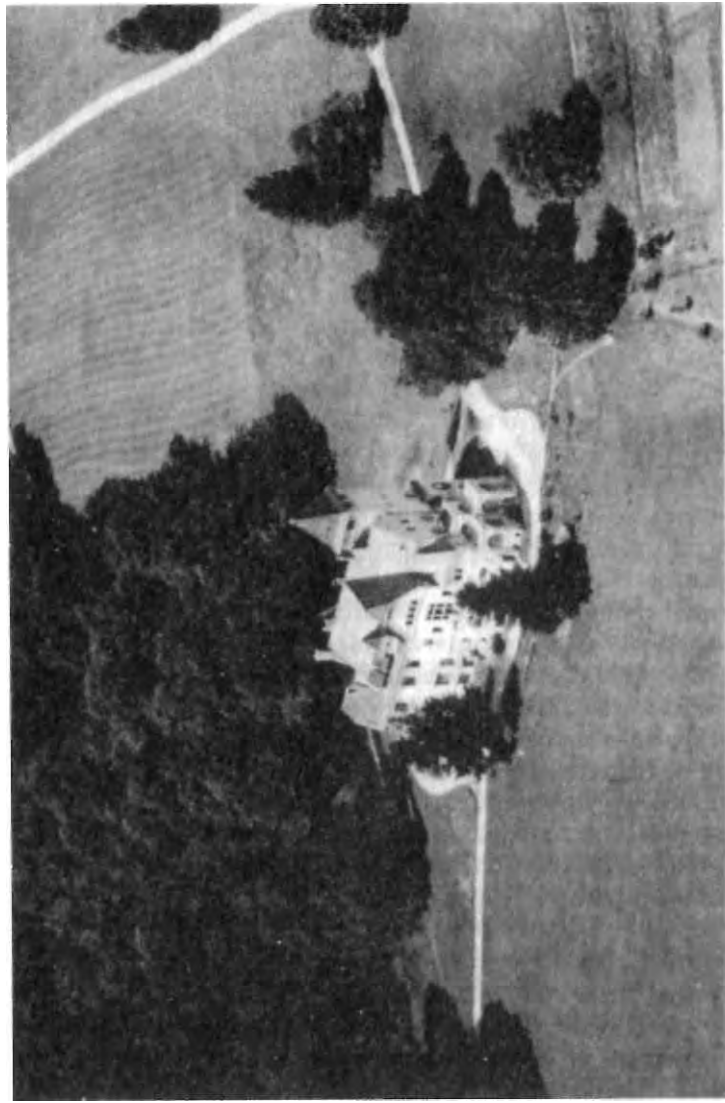

Pythagoras-Kepler School. Biotechnical Academy, Bad Ischl.

Here it is also of interest to note that if we accept the law of the formation and development of sound as a general law of the universe, it follows mathematically that the universe has a spiral structure. If the theory of the law of sound is correct then Viktor Schauberger's understanding of the 'cycloid spiral motion' as being life's own developing motion, is confirmed.<sup>32</sup>

The discoveries of two well-known physicists seem to support Viktor Schauberger's theories. The first is Ludwig Boltzmann (1804-1906) whose special field of research was steam technology, the efficiency of which he wanted to improve. To reach the pressures and the high temperatures that this technology demanded, Boltzmann found that the steam's or gas's molecules must be made to move in a straight line for high efficiency. At the same time he made the disappointing discovery that it was virtually impossible to create this straight-line movement, even with two-atom gases, such as hydrogen. When the two-atom gas was exposed to a moving impulse, it wanted to begin to spin, whereby its own rotation 'ate up' a large part of the energy created, leaving only a small amount to remain. It was even worse with multiple-atom gases, such as water steam, where a 'straight motion' was even more difficult to achieve. Boltzmann was very disappointed by these findings, for he thought the study of heat and heat technology were the most important base for the existing technology, and if high efficiency could not be obtained, then it must mean that Nature is mistaken. Low efficiency will cause such extensive fuel depletion, that soon we will exhaust the world's energy supplies, he thought. The situation today shows that Boltzmann's fears were justified. At the same time, however, his discoveries confirm Viktor Schauberger's argument that Nature tries to prevent straight line motion. Small particles wish rather to move in a 'planetary' orbit, rather than to be forced into the straight-line motion which suits our technology. When technologists now continue to use this incorrect model of motion, they are also responsible for the plundering of earth's oil and coal supplies.

The other scientist who, without knowing it, confirmed with his experiments Viktor Schauberger's 'spiral motion' theory was Felix Ehrenhaft (1879-1952), Professor of Physics at Vienna University. Ehrenhaft developed the experiments of other scientists concerning the study of small particles of matter in magnetic fields and/or concentrated light rays. Fine



powdered material, for example silver, copper, chrome, coal etc. and even fine water droplets were introduced into evacuated glass tubes. As a tube was shaken the particles moved in suspension. If the particles were then exposed to concentrated rays of light, they started to follow certain paths, in that they turned into a path in a uniform way. Ehrenhaft wrote about this:

Totally new and surprising was that the particles' motion in the field was not straight, but flowed in screw-like paths with a most regular form, size and uniformity... drops of methyl orange for example ... moved in this way.

Similar results were obtained when the particles were exposed to the influence of a magnetic field. Local gas flows or the 'charge' of the particles were no explanation for the screw-like paths that resulted, which remained unaffected by such influences.

Also interesting was the fact that a centripetal power occurred that influenced particles 130 times more strongly than gravity.

Ehrenhaft's comments on the tests:

It is improbable that these phenomena of motion in light or magnetic fields can be explained with the help of existing hypotheses; we may be forced to turn to new ones.

Walter Schaubeger has interpreted the test as follows:

Each energy particle in motion produces a field- an energy room - which is dependent on the motion, and the more concentrated this field is, the more it influences the surroundings, so that particles with a larger mass than the field producing particle can be drawn into the field. These particles of silver, nickel or carbon in comparison to light photons must be like huge boulders, but they were still drawn into the photons' swirling dance. We must therefore learn to move matter, when we can, in the way electrons and photons move ... and so with relatively small amounts of energy we will be able to move 'mountains'.

In short, Ehrenhaft's experiments indicate that Nature's

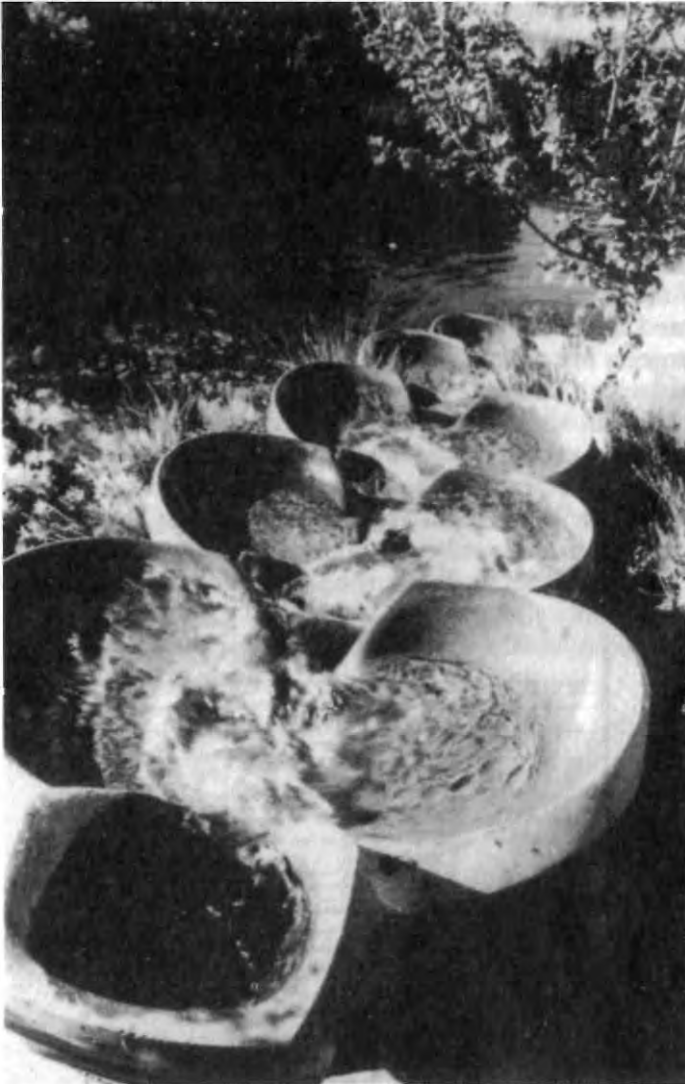

Virbela Flowforms are designed using a method developed by A. John Wilkes since 1970. The illustration shows one such vessel in series. Water streaming through the system pulsates rhythmically in a vortical meander creating a figure of eight flow path.

The quality of water thus treated is being investigated for its increased life supportive capacity, for the rhythmical character of all organisms and that of the overall environment maintains the reciprocal relationship between them.

most basic elements move in the spiral motion that Viktor Schaubерger wanted to copy.

### Continuing Research

After Viktor Schaubерger's death, biotechnical research has, in a practical way, concentrated on developing new methods and apparatus for the caring of the environment and for bio-synthesis. In Sweden there has also been background research into the physics of water and forests, from the direction pointed to by Schaubерger's work.

Projects for water and air filtration, usually led by Walter Schaubерger, has led to new patents for models of apparatus. On the following page is shown an apparatus for exhaust control on motor vehicles or heating installations. Other variations of this can be used for promoting other reactions, for example, synthesis. The models shown have specially shaped-reaction chambers of a certain material that is important as a catalyst. Built for the separation of, for example,

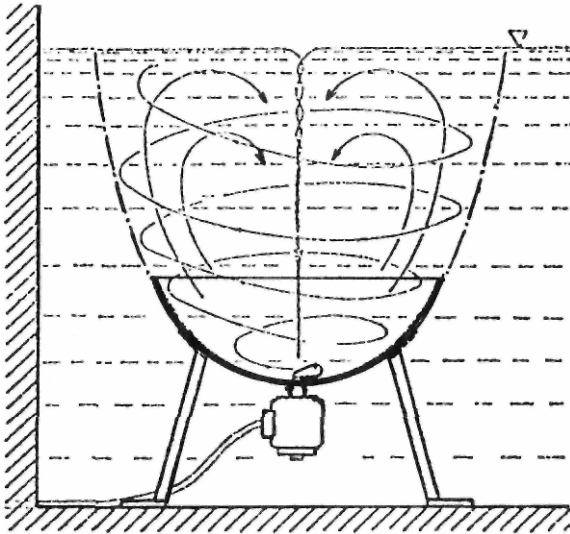

This diagram shows an apparatus for oxygenating water. A specially-designed agitator is attached to a suitably-shaped reaction vessel in a water reservoir. The agitator creates a whirlpool-like swirl which sucks air into the water. The increased oxygenation breaks down pollution.

sulphur dioxide from exhaust gases, these enter the chamber at inlet A, at a certain pressure, and are directed into a strong, wavering motion through the chamber's inner wall, down towards the narrower neck, where they mix with the reaction mixture, in this case water, which is drawn in through B. The sulphur dioxide reacts with water and sulphuric acid is formed. This then moves in a spiral upwards to the lengthened pipe, C, finally to drain out via the outlet. The exhaust gases freed from the sulphur flow at the same time through the same pipe, concentrated within the pipe's narrow longitudinal shape.

### Viktor Schauberger's View of Attitudes to Nature and Environmental Care

It is likely that Viktor Schauberger's ideas, and the research he has inspired, will stimulate radical new thinking about environmental care on several different fronts. He criticized prevailing science's understanding of Nature for 'thinking one octave too low'. He meant that the mechanical materialistic approach dominated at the expense of a qualitative view of Nature.

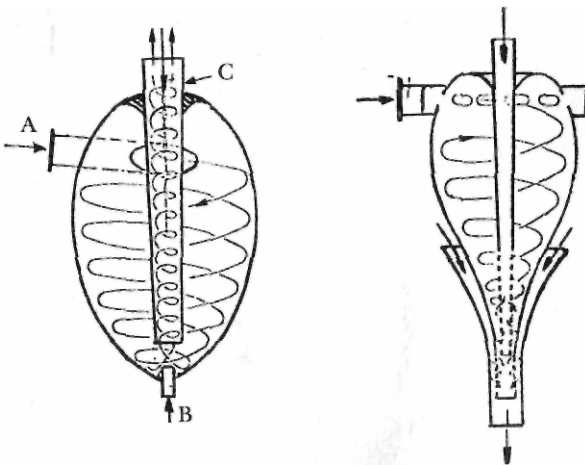

Two variations of an accelerator for nuclear fusion. Schauberger worked on these prototypes as safer alternatives to the reactors currently used in nuclear power stations.

In considering what the last decade has revealed about the extent of environmental destruction, and what ecological research has already discovered, there seems to be considerable justification for Viktor Schauberger's indictments. Ill-founded economic and technological priorities, and the compulsion towards profitability, still dominate our relationship with Nature, and even the protective measures which have now begun in a startled way still all too often lie 'one octave below' Nature's own way of working.

Viktor Schauberger has given fairly clear principles to guide us to a more realistic programme for saving and caring for our living environment. It is an urgent question for science at all levels to work out specific directions from these fundamental truths. It is probably the most urgent of all tasks facing science



A nebula spiral, as a cosmic vortex.

today. Politicians and economists will also have to undertake a new way of thinking. Nature can no longer be regarded as a base for material well-being. It is the basis for our life, and if we harm it through over-exploitation then the quality of life will be quickly undermined until there is a final biological breakdown. A general biological catastrophe when the air, water and nutrition cycles can no longer function as fundamental life factors, must necessarily be followed by an economic, social and political breakdown.

Only by nursing these life factors can we ensure a safe base for future well-being. It is Viktor Schauberger's legacy to have been a pioneer in showing and emphasizing the connection between Nature's health and the happiness and well-being of mankind.

#### Organisations Pursuing Research with Water

Max-Planck-Institut für Stromungsforschung  
Prof. E. A. Müller, D-3400 Göttingen, West Germany

Sternwarte am Goethaenum  
Dr. Georg Unger, CH-4143 Dornach, Switzerland

Warmonderhof Waterzuiveringsproject,  
Dr. Jan Diek van Mansfelt, NL-4012 NR Kerk Avegaath,  
Holland

Forschungs und Versuchsanstalt der Stadt Wien,  
Dipl. Ing. Dr. Paul Schutz, Rinnbockstrasse 15, A-Wien,  
Austria

Pythagoras- Kepler- Schule,  
A-4821, Lauffen, Austria

Flow Design Research Institute,  
Emerson College, Forest Row, Sussex RH18 5JU, England

Geothean Science Foundation,  
Olive Whicher, Hoathley Hill, West Hoathley, Sussex,  
England.

Nettlestone Laboratory,  
N. C. Thomas, 163 Toms Lane, Kings Langley, Herts,  
England.

Institutet for Ekologisk Teknik,  
Nygatan 60, S-902, 47 Umea, Sweden.

# APPENDIX I

## Contemporary Applications of Vortex Research

by Christopher Seebach

When, as children, we see the water spiralling down the bathtub drain, we can become aware that Nature works in a spiral. We later discover other phenomena in which this spin occurs, such as DNA, cyclones, beanstalks, magnets, galaxies and other forms of Nature, but few have considered that the spiral is the force behind all of Nature as have scientists like Schauburger, Pythagoras, John Ernst Worrell Keely (1837-1898) and Nichola Tesla (1856-1943).

Vortexian energies are the keys to life, for they are mirrored inside every living being of the planet. Once one realises this, then the whole notion of 'mystery' simply falls away. Walk through a forest, see a stream, look at your reflections in the stream; every part of that experience, on all levels, both visible and invisible, physical and spiritual is connected, for all of these are vortexian energy. It is not a question of harnessing this energy, but of releasing it from its confines and working with it in harmony. Vortexian energy, particularly in the case of water, derives from sympathetic harmonies and the avoidance of disharmony, as in the flow of energy patterns that are created by water as it becomes living water by moving through the bowels of the earth. This is a complex interplay of 'vibration', 'direction' and 'force', each of which is balanced both internally and externally. How is this energy to be released? The key here is the way in which this is done; for one needs to be in harmony with the planet in order to discover these sources of energy. Humanity has lived for so long under the spell of reductive science that it now requires totally new ways of understanding and perceiving in order to come to



terms with the existence and power of this energy. Natural spring or revitalised water does indeed 'live', not because it gives life, but because it is life, and of itself. Chemical analysis is inadequate in determining the biological properties of living/activated water\*. Any hydromineral therapist will tell you that you must drink the spring water from the source of a spa gradually (a quarter of a cup per day) or you will shock your system and become very ill until you get accustomed to it; alternatively you could drink the same water from a bottle several weeks later with no ill effect. (C. L. Kervan<sup>1</sup> 1966)

'Dead' water is often the result of humanity interfering with the water's natural flow and energy forces. Water creates and follows energy lines in the Earth. These lines are mirrors of the frequencies put out by the effects of water's vortexian energy. This mirroring\*\* allows the water to move freely with no friction. Thus, if craft are to be designed to be able to use vortexian energy as a motive force\*\*\*, they would do so not because of the power generated to overcome gravity and other forms of resistance, but because a frequency was set up which was in total harmony with the energies that lie at the heart of all matter. Thus there is no 'friction' or energy 'imbalance' between the matter that is trying to move and that which surrounds it. What is created is not a vacuum, but a field of

"The formula of water  $H_2O$  could only be a simplification, perhaps admissible in the state of steam, but certainly not in the liquid state where there are ionised molecules. Water has been proved to contain  $H_3O^+$  though in a small quantity, it also appears to contain  $H_5O_2^+$ ,  $H_7O_3^+$ . It is now accepted that hydronium ( $H_3O^+$ ) is an acid since it can give up a proton to the basic hydroxyl  $OH^-$  which then becomes  $H_2O$ .  $H_2O$  is thus either an acid or a base, depending upon the medium, because in giving up one proton  $OH^-$  remains, and in taking a proton up there is  $H_3O^+$  (Water is therefore amphiprotic). Ref: C. L. Kervan<sup>1</sup> 1966 "Biological Transmutations" Crosby Lockwood.

\*\*As to mirroring, specifically, we mean the setting of a harmonic frequency or resonance that duplicates that frequency range required for vortexian motion to occur unhindered. Indeed one could look at Nature as in perpetual vortexian motion, but there is a constant brake on it, so vortexian energy is only occasionally seen.

\*\*\*Sympathetic vibration in its simplicity is a usable force in activity; yet, with the radial activity of the latent force given in the sympathetic, synthetic, or syncothetic conditions, it then brings about the proper relationships which converts men into a usable force. Build upon the principle set forth here. Bringing the combination or relativity of elements with the active force of sympathetic vibration into relationship creates a usable motive force. This may be applied in various forms to any active principle (paraphrased). Edgar Cayce (1877-1945) Association for Research and Enlightenment, Virginia Beach, USA.

"Ere many generations pass our machinery will be driven by power obtainable at any point in the universe ... it is a mere question of time when men will succeed in attaching their machinery to the very wheelwork of nature". Nicola Tesla (1891)

harmony requiring very little or no force for actual movement through space, time or dimension.

In order for us to view the principles in the Austrian log chute project (see page 25), we must view nature from its own perspective and its very heart-parallel or clones of vortexian energy - rather than from a distorted view of reflection. Vortexian motion is present in all things - vortexian energy is created by the interplay between vortexian motion and the effect this motion has on that matter\* that is placed next to it.\*\* Different materials will have different 'resistances' to the transfer of vortexian motion from the mechanical surface to the water to be energised by the mechanical agitation of the water. The energising is affected by the density and molecular structure of the materials involved in the construction of the machine. Thus, when the water is given a vortexian motion by the design of the log chute, it transmits that motion to the surface molecules of the water and this transmission and the creation of a sympathetic frequency cause friction between the two to be removed, friction being disharmony and the result is the release or achievement/recognition of vortexian energy. Small temperature differences in the surface of the water affect the molecular structure of the surface that interacts with that of the wood on the chute, and the transfer of vortexian motion is affected by this molecular structure. In reality, it is the absence of friction that causes the motion, however, this is the result of energy which could be called vortexian energy as that is the source which creates it.

I was asked to write this article on the practical uses of this science, what it is and how vital it is today, from my own experience with the Aquarian Agency. Aquarian is a global service organisation of scientists, engineers, professionals, grass-root and alternative specialists in virtually every aspect of development from over 40 countries. All of their efforts have been combined to produce between them totally original viable solutions which will work with Nature's rhythms. By enhancing the processes based on principles of natural law, we

\*"There is no dividing of matter and force into two distinct terms, as they both are ONE. Force is liberated matter. Matter is force in bondage". Keely<sup>2</sup> 1893

\*\*"Coherent aggregates (any specific body (logs)) immersed in a medium (such as water or atmosphere) pulsating at their natural pitch (eigen frequency) simultaneously oscillate with the same frequency (of the medium), whether the pitch of the medium be a unison, or any harmonic (partial or component) of the fundamental (eigen frequency) pitch of the creative aggregate (body)". Keely 1893. (My italics)

will create optimum conditions to accelerate the growth of plants and trees (without forcing them) in reforestation programmes, while selectively creating an ideal environment for sustainable future ecosystems to develop. We have, in the course of the last twelve years, discovered the tools and methods to accomplish this, and a few are described below to illustrate the practical present-day applications based on the same principles Viktor Schauberger researched.

Aquarian was formed twelve years ago when a group of multi-disciplined professionals, became aware of the probable impact of major planet-wide cold and famine/drought cycles (occurring every 510 and 170 years) converging in these decades, combined with a rise in pollution levels (which threatened to reverse the cold trend to dangerous levels), anticipated the need for a socially, financially and scientifically viable sustainable form of development project which would provide the means for a solution. The solution promises that this planet does not have to become uninhabitable, nor does it have to repeat its past history of greenhouse effects, ocean risings and ice ages! A global reforestation project in selected areas would influence the (macro) vortices of temperature, weather, and tidal flows to produce a harmonious and stable series of climate cycles. (Little attention is being paid to the thermal ocean currents and subsequent tidal changes being brought about by the greenhouse effect, nor the effect of the deforestation of Brasil and Central Africa on wind currents, on the Gulf Stream and other ocean currents.) This project would need to have the capacity to green both deserts and denuded forests, as well as have the right mix of agroforestry and intercropping of undergrowth species (for medicinal herbs, insect repellents, wildlife and remineralisation through decay) which would evolve during the next century into a self-sustaining ecosystem. It would also provide nourishment and an independent thriving economy for the communities maintaining these forests.

It became apparent over the years that programmes based on inorganic chemicals and selective mono-cultures would not work on a permanent basis. This will be attested by any who have witnessed the barren grey soil 7-12 years after a 'green revolution' project, which accomplished much needed miracles over a short term, but had to face the annual increase in costs of chemicals, industrial equipment and other major

social and ecological costs. Therefore a natural and permanent self-sustaining system must be implemented.

Much of the Aquarian solution is made feasible by our ability to irrigate fully a billion new trees per year with desalinated water, provided at a fraction of normal capital, running and maintenance costs, using solar energy. Desalinated water is, however, lifeless. In our search for natural and cost effective ways to revivify it, we came across scientists who, like Viktor Schauberger, have been working with Nature to obtain the understanding to provide their solutions.

When rain falls, like distilled water, it is without life. It trickles down in spiraling motions around rocks beneath the ground, where it gradually meets a rising temperature, and begins at some point to percolate upwards, again in a spiraling motion, gathering mineral ions and life force until it meets light. There is a story that Schauberger once asked a farmer why there was a litde structure of rocks over the mouth of a stream. It was explained to him that if its shade was removed and the light let in the flow would stop. Schauberger had his men draw a diagram of the structure and dismantled it. The water flow did stop. The structure was replaced and the flow recommenced. This helped us to understand why rivers and streams disappear so quickly during deforestation, when the ground cover is removed. We will, in the future, be testing this by placing geodesic greenhouse domes ('Aquarian Oasis Starters') over such deforested areas, planting trees and undergrowth to encourage the water to flow again. Care must be taken to assure that when we are over aquifers (underground lakes of water), we are resurrecting mature living water on its way up and not dead water on its way down.

At the Emerson College (Rudolf Steiner's<sup>3</sup> biodynamics) in Sussex, England, tutor, sculptor and designer John Wilkes has been working on the development of 'flowforms' which transmute and purify water as it flows through a course of basins shaped in such a way as to cause a double vortex in a figure of eight, creating lemniscatory oscillation (See p. 135). Aquarian will be using John Wilkes's 'Flowforms' to revitalise the desalinated water and, subsequendy the soil, thus giving the plants additional life force and mineralisation to resist disease and attain their optimum yield.

Relatively litde attention has been paid to the nature and vital quality of the water used in research on plants and soil or

in studies or mixes for mortars and other building materials. There is a related technology that we may use, invented and developed by Wilfred Hacheney, based on vortexian motion, which is a water treatment machine consisting of a hyperbolic cylinder made of high grade steel and having, in the centre, a funnel shaped device placed over a blade rotating at six thousand rpm creating a non-euclidian path of motion. The enclosure shape and internal design of the cylindrical device causes a change in the direction of flow at regular intervals. At the moment of direction reversal, the water particles are subjected to extremely high acceleration, while any turbulence is avoided. This creates suction energy which is stored into the water in the form of micro-vortices. This process can be defined as a physical energising of the water which is hence called energised or 'E-water'.

Some of the laboratory-proven effects of water energised by such treatment are particularly interesting from our point of view, having as they do very practical and exciting applications:

1. Plants in soil watered with 'E-water' grow faster with many times higher seedling survival rate. This results in higher values for plant growth, crop yield, crop quality and resistance of the plants to disease and pests. Packaged produce and food products prepared from these plants have a considerably longer shelf life.

2. Aquarian has developed building materials which can be made using the finest wind-blown desert sand and by the conversion of toxic waste products, like gypsum sulphate, which is derived from scrubbing sulphur from the flue gases of coal fired power stations, and gypsum phosphate waste derived from the manufacture of artificial fertilizer. These toxic materials are actually transmuted into a previously unfamiliar form of non-toxic hydraulic binding material through heat controlled vortexian action. Such building materials are invaluable in our programme for on-site construction of desalination plants, irrigation systems, superior housing, workers' accommodation, schools etc and in deserts where the cost of shipping materials would render such programmes difficult. 'E-water' changes the mineral structure of such hydraulic binders or potentially hydraulic binding materials. The presence of 'E-water' in cement mixtures, hydraulic lines and dessicated clay or clay sand mixtures mainly results in the development of an amorphous structure

of the minerals instead of the normally expected crystalline mineral structure. This modification of the physical properties of the water mixed in this fashion with solid particles, creates unusually highly colloidal states\* which lead to the following practical effects: considerably higher bonding capacity of the neat cement; higher resistance in compression and bending of the concrete; chemical resistance of the concrete up to pH2. New materials containing clay made to meet specific physical requirements (e.g. elasticity, resistance, installation against noise and temperature, heat retention, absorption of the electro-magnetic radiation, etc.) can now be made without going through a furnace.

3. The building materials and products derived from gypsum waste (mentioned above) have been developed by an application of vortexian action induced by a warped Achimedes (or Tesla) screw. The screw induces a slow build-up of heat (as in the conversion underground of natural rain water) in the gypsum waste and converts it into a plaster-like hydraulic binder material which sets like stone similar to that in the Cheops Pyramid in Egypt. This can be mixed with fly ash or other aggregates and the subsequent products resist heat up to 2,400°C for several hours and cold to minus 170°C, representing a major breakthrough in construction and building safety. Variation of the production process permits selective control of the setting-time and/or permeability, and the material will set even underwater (fresh/salt). Conduits similar to those found in ancient Iran and Babylon can be made where water seeps at a controlled rate for underground irrigation without salination or evaporation, and is easily moulded into flowforms, irrigation canals or pipes. Pipes can be made, according to designs by Walter Baumgartner,<sup>4</sup> which use vortexian generation to propel the water to the point where it produces negative friction. This allows us to use vortex-action water pumps and Victor Sorokine's<sup>5</sup> 'Self-Adjusting Turbine' to transport irrigation/drinking water with little power consumption over vast areas of desert. Baumgartner, Hacheney, indeed, Walter Schauburger (Viktor's son) and others like

\*Activated water, when heated, removes the scale inside boilers; the adhering calcareous substance (the scale) is insoluble in ordinary water, but in this same water, activated, precipitates this calcareous substance in a colloidal form ... it is evident that activated water can have important effects on the organism, as living cells are mainly composed of colloids. (C. L. Kervan 1966)<sup>1</sup>

them, through their visionary and practical applications of vortexian energy are leading us into the 21<sup>st</sup> century, with the prospect of virtually free energy and an understanding of Nature in all her workings.

These are special times demanding new solutions of simplicity and clarity to replace those crystalised structures which imprison our perspective of reality. We are, as a civilisation, trapped in a cycle of conditioned thought formulae which carry us like a whirlpool's vortex into foregone conclusions.

To obtain real solutions, one should no longer strive to deal with the symptom but its cause (which can usually be attributed to imbalance); for solutions often have nothing to do with the presented problems. This requires us to use the right hemisphere of our brain<sup>6</sup> to 'see' the solution using contemplation, brainstorming and lateral thinking; then only using the left hemisphere to work back deductively and scientifically in pinpointing the method to be used to implement the solution (but not to think!). We need to look at science in the same manner - simply and clearly, if we are to even grasp the works of Viktor Schauberger and other scientists like him who have broken from the mould of trying to understand the ways of Nature by reducing her wonders to formulae and calculations created by men for men. We need to look at the notions of the 'mysteries' of Nature which are 'mysteries' only to humanity. This does not stop Nature from working, from being, from existing. Nature stands apart from human intellect, but this does not mean we cannot work alongside Nature. Nature has no secrets — only we have limitations in the way we approach and understand Nature. This means more than seeing Nature as a reflection or a distortion of its mirror image, but as parallels or clones of which we can be but one example.

Water lives at all times, it just needs to be released from its confines that our use of it has until now put it in.

1. C. L. Kervan (recently deceased) wrote three books (in French) on biological transmutations which occur regularly in Nature e.g., plants taking up larger amounts of magnesium than were available to them in the soil (Aquarian plans to use this knowledge to regenerate and re-mineralise the soils in self-sustaining agroforestry through undergrowth decay of plants which naturally 'manufacture' minerals required by trees etc.). Considerable scientific interest has developed in Belgium, Switzerland and Japan as a result of this work.

2. Keely was a pioneer of sympathetic vibratory physics and like Viktor Schauberger, is still the source of important study groups. The focaliser and publicist of a journal is Dale Pond of Delta Spectrum Research Inc., 4810 Airport Road, Colorado Springs, Colorado 80916, USA.
3. Rudolf Steiner (1861-1925) was the founder of the Anthroposophical movement. He believed that humankind could help Nature take a step above herself. With our cooperation, something is created which natural processes alone would not bring about. Humankind, acting out of knowledge and with the help of Nature and her products, takes a step beyond Nature, assists in her development, becoming once again, a constructive participant in world evolution, not merely preserving and living from the fruits of the earth, but building and helping in Creation.
4. Walter P. Baumgartner is an expert on vortexian energy and its technical applications. He has a magazine "Energy Unlimited" offering news on scientific R&D in this field. (N.B. issue #20) Energy Unlimited, PO Box 3110, Laredo, Texas 78004, USA.
5. Victor Sorokine has over a thousand inventions of which many are concerned with water and the vortex. His vortex action Self Adjusting Turbine (Turbine Auto-Reglee) with constant C.O.E. up to 9896 is noiseless and without turbulence.
6. Buckminster Fuller in his book Critical Path stated that the only hope for humankind was that we use our transcendental mind (right hemisphere) for thinking and our left brain only for storage of information, as it is incapable of true thought. Astronaut Edgar Mitchell is noted for similar views and states that NASA trained all their astronauts to function this way as "up there that is all you can rely on". He calls the use of the left brain for thinking "the scourge of humankind".

The Aquarian Agency Ltd., is a global service agency and consultancy comprising people, technologies, and initiatives in over forty countries with an ever-evolving group vision and demonstration of what humanity and the technologies working with and for Nature can achieve. (Enquiries and/or participation welcomed.) Aquarian Agency Ltd, 405 Kingston Rd., Wimbledon Chase, London, SW20 8JS, England. Tel/fax (01) 543 5956



# APPENDIX II

## Physics and the Vortex

by Peter Hewitt

The concept of the vortex was central to Schauberger's work. It is also emerging to have application to fundamental physics. The vortex is a key principle which casts new light on the findings of physics. The vortex points to a completely new understanding of the physical world. At the same time, it opens the door to the super-physical.

To most of us, the physical world seems solid and substantial. Yet modern physics has shown quite clearly that this solidity is an illusion. Matter is made up of atoms and these atoms themselves are mainly empty space, containing sub-atomic particles such as protons and electrons in constant movement.

These sub-atomic particles themselves are far from substantial. Ever since Einstein, we have known that matter is equivalent to energy. Particles, in some way, are bundles of pure energy.

But this equivalence of matter and energy is a mystery. No one understands how particles of matter, seemingly so stable, can be a form of energy, which is dynamic and ephemeral. Modern physics knows that this is so, and exploits this fact, without understanding why.

It is this central mystery of modern physics that the vortex can explain. The new idea is that a sub-atomic particle is a vortex of energy. This is a simple principle, but it has immense power. The vortex has the potential to provide an entirely new foundation for physics.

The vortex begins to explain the properties of particles for the first time. Particles are a paradox in physics. Sometimes they behave as little point-like things; sometimes they behave as waves. If particles are really vortices of energy, many of these paradoxes can be resolved. The complexity of physics melts away.

Einstein described matter as "frozen energy". The vortex shows that the energy in matter, so far from being frozen, is in constant movement. From this starting point, it is easy to explain the dynamic properties of particles.

Matter acts dynamically on other bits of matter. It can even act 'at a distance' - across apparently empty space. We are all familiar with the way two magnets bounce off each other- or attract - without touching. If particles are pictured as inert 'blobs' of material, these effects are very hard to explain. But if particles of matter are really extended vortices, it becomes very easy to see how they can interact with each other to create such effects as electric charge and magnetism.

The vortex, as it is developed, shows that even apparently empty space is full of energy. It makes clear how this energy relates to matter, and how 'subtle' energies interact with the physical world.

Some of the extraordinary effects that Schauburger produced may be explicable in terms of a resonance effect between these subtle energies and the energy in matter. Vortices in air or water, moving in the same form as the underlying energy in matter, could exchange energy with them. This principle can be seen in the tuning fork. Sound a tuning fork in a room with the piano, and every string on the piano tuned to that note will start to vibrate in sympathy. The enormous energies released through Schauburger's vortex might be the result of a similar resonance effect. If so, he may have found away of tapping not only the energy locked up in matter, but also the 'cosmic' energies of space.

These ideas are admittedly speculative. But they point to a possible explanation of otherwise mysterious and inexplicable phenomena. Since Schauburger, others have built flying saucers and 'energy machines' that run on no fuel. But invariably they have little or no idea why they work and, lacking such insight, progress only when underpinned with adequate theoretical foundations. It may be that the new physics of the vortex could one day provide the framework of theory that enables Schauburger's vortex to be exploited to the full.

Peter Hewitt has been working since 1987 with David Ash, the originator of the physics of the vortex. Together they are writing a series of books, the first of which *Science of the Gods* is published by Gateway Books. (Sept. 1990).

# NOTES

1 This description is not as fantastic as it first appears. A body's ability to float in a liquid is dependent on the relationship between the specific weight of the body and that of the liquid. If the liquid has a higher specific weight than the body, the latter floats. If the liquid can be concentrated, as for example, by a certain kind of swirling motion, its specific weight is increased. Anyone can make the following test: take a test tube 30-50cm long with an inner diameter 5-8cm. Fill it with water. Carefully insert an egg which will sink to the bottom. With a suitable stirring, which can be quite gentle, the egg rises to the surface, and stays there until the motion ceases. In the case of the dancing stones, the water was already concentrated (it was a natural stream, in a natural setting, and the night was cold). For further information see Kosmische Evolution, No.4, 1969, p.24 ('Die Scheinbare Dichtesteigerung Von Wasser in Einroll Wirbel' - 'The apparent increase in water density in simple whirlpools').

2 Cycloid space-curve motion is a central theme of Schauberger's thinking. He speaks even of 'planetary motion' and 'imploding motion'. Think of a particle gliding along a spiralling thread wound around a cone, towards its tip, for an impression of this motion.

3 Jurgen Sauk is carrying out a water regulating scheme in Brazil (following Schauberger's methods) on the 800 kilometre Panama River (1979): Implosion No. 63.

4 Harry Martinsson: 'The silt in a river always carries the potential of becoming soil to sustain plant life.'

5 This understanding of Schauberger's seems to be confirmed by the New Zealand physicist B. St Clair-Corcoran. He calculates a country's rational use of natural resources by testing the quality of the water. In this context 'rational' means such usage that preserves nature's dynamic ecological balance. By measuring the water's negative entropy, 'Nentropy' i.e. characteristics of its molecular structure, a statistical understanding can be obtained of what Corcoran means by the water's quality: its ability optimally to transport material is healthy energy. As the landscape's ecological condition also effects 'nentropy', it becomes an indicator of how a country treats its forests, land and watercourses, etc (Journal of Hydrology, N.Z. vol.10, No. 2, 1971).

6 Die Wasserwirtschaft, No. 24, 1930.

7 Schauberger did not believe that the blood was pumped by the heart, but had its own power of motion, like water. This has also, more recently, been shown by Professor Manteufel, Warskw ('The Heart is not a Pump') *Komische Evolution* 2, 1971.

8 S. Hedin: *The Flight of Large Horses*, P. 40, Stockholm (1935).

9 In *Varle Och Vetande*, No. 1, 1966, J. Westbury describes similar occurrences on Scottish lochs to those on the Odemark lakes.

10 Schauberger thoroughly investigates this in *Hydrotechnology*, No. 20, 1930.

11 Schauberger here means the influence that the pipe material has on the resistance to flow. See the experiment in Niirberg.

12 Dr W Drobeck, head of Hamburg's waterworks, with the help of the so-called 'Steigbild' (growth pattern) investigations (water is absorbed in a suspended strip of filter paper) reveals clear changes in water that has been exposed to centrifugal treatment, e.g. pressure pump. 'Gedanken ubereine Grosstadt Wasser-Versorgung' (Ideas on the water supply for a large town). *Das Gas-und-Wasserfach*, 108, 1967, H40, 52, 109; 1968, H8).

13 Schauberger is probably here referring to the situation in Central Europe.

14 This building-up of metal has also been verified by Professor P. Baranger at the Ecole Polytechnique in Paris (*Modern Earth*, Paris, 1960). Baranger found that it was not only a concentration of metals from the soil at the place of growth, but an actual new formation of them.

15 The centrifugal form of motion can be equated to the principle of entropy in physics (all processes of energy move towards the highest disorder). The centripetal form of motion of negative entropy, found for example within the bio-electrical potential of the living cell, has, on the other hand, the potential for energy to move towards order. (See, for example, E. Schroedinger: *What is Life?* (Cambridge, 1951).

16 Diamagnetism is what is sometimes referred to as cross-magnetism, when certain bodies, subjected to a magnetic field, take up a position at right angles to the magnetic axis, that is east-west instead of north-south.

17 It is important to note that Schauberger's biological magnetism is not the same as the diamagnetism of physics. His 'biological magnetism' is more to do with trace elements and 'chromosomes'. See Footnote 18.

18 What Schauberger called 'trace elements' and the 'chromosomes' of air and water are not trace elements and chromosomes in the generally accepted sense, but his terms for the 'smallest forms of living substance', when an organism decays in death. They then exist as indifferent, unconscious life carriers, until they are sucked into one of the two motions. It is of interest to compare this theory with that of Professor Bechamp's concerning 'microsymers', the cell's physiologically indestructible element, that he considers to be active in life's construction as well as destruction. (See A. Waerland, *Vagen Till en ny Mansklihet*, (The

way to a new humanity, Halsans Forlag, Linköping). In Wiener Medizinische Wochenschrift, Nos.37-38, 1951, H.P. Rusch and Anto presented proof that the cell centre, the genes, chromosomes etc. do not die when the organism dies, but continue to exist by changing into other special forms.

19 Implosion, No. 41, p.23. The last model of this machine was taken to the U.S.A. in 1958 and was kept by the Americans.

20 Implosion, No.49 (Kokaly, A, 'Das Erbe Viktor Schaubberger').

21 The tests have been taken up by Swedish bionic researchers in recent years. Results of these are presented in Implosion, No. 6.

22 In Implosion, No.9, Walter Schaubberger presented the idea of the 'biocondensator', that is formed by the geosphere and atmosphere and the insulation cover in between. His presentation provides a new and interesting understanding of growth.

23 In biological, ecological agriculture, as expounded by Dr H. Muller and H. P. Rusch the importance of a constant soil cover is stressed. See, Rusch Naturwissenschaft von Morgen, (Rusch, Tomorrow's Natural Science), Frankfurt/Main and Cibulka den Fruktbare Tradgarden (The Fruitful Garden) (Orbio, Box 6002, 600 06 Norrköping).

24 It is unclear here, what Schaubberger means by 'neutral voltage' and 'neutral charge'. Possibly he thinks that the layer between the negative geosphere and the positive atmosphere can attract either polarity, depending on other circumstances (see also note 48).

25 Schaubberger, using the term 'fructification' means, in general, the use of all carbon and hydrogen compounds, while 'fertilization' includes all oxygen compounds.

26 The rationale behind 'sun ploughing' was that the upturned sod should not only be exposed to the sun along one side, as it would then become too hot, and 'discharge' its energy.

27 Presented in the Institution's Yearbook 1949, 1952, pp. 109-112.

28 Walter Schaubberger has since patented a 'biometal alloy' for farming and gardening equipment. These are sold by, amongst others, the Biotechnisch Gerate GmbH, 5604, Neviges (Rhld). Successful tests with these tools have been carried out.

29 Positive results from experiments with the 'repulsator' are outlined in Implosion No. 42.

30 The experiment has been repeated by Swedish bionic scientists with similar results.

31 Professor Popel's findings are published in Komische Evolution No. 3,1977.

32 The New Zealand scientist Brian St. Clair Corcoran has also developed a world model in which the universe has a spiral structure, quite independently of Schaubberger's research.

34 Water not exposed to sunlight has a greater density and vitality. Its inner structure becomes changed and weakened by an increase in temperature.

35 Prince Adolph was so pleased with Schauberger's efforts that he wanted to bestow upon him the title of Forstmeister. Since Schauberger did not have the requisite degree in forestry, to have done so would have outraged all the other Forstmeisters (Forest Superintendent). However, not to be thwarted in his desire to reward Schauberger for his services, Prince Adolph awarded him the title of Wildmeister or 'master of the wilderness', a term specially coined for him.

36 Schauberger's log flume allowed commercial exploitation of virgin forests which had been inaccessible to the foresters because of the nature of the terrain. He was so upset at having to witness the brutal damage done to natural forests exploited by short-sighted greed. Rather than have to take responsibility for the conditions of the forest that he saw would be inevitable, he resigned from the Prince's employ, without taking a penny.

It was after this that he was offered employment with the government, and was eventually raised to the level of grade three hofrat (literally court counsellor). His unconventional background and personality made him much resented by all the other hofrats, which caused him in the end to resign from government service.

37 Schauberger felt quite put out by being given only a gold watch for his efforts, when Steinhard received a million schillings as a result of Schauberger's ingenuity and knowledge. He thought it underhand and quite unfair.

38 With a rise in the general temperature level due to deforestation, the ground becomes too 'hot' to support water at a temperature of around  $4^{\circ}\text{C}$  at its normal natural distance from the surface. On the basis of the Archimedian principle, water can only 'float' at a level of equal temperatures. When the ground temperature rises, the  $+4^{\circ}\text{C}$  water table must fall.

42 Nuclear power, in terms of atomic fusion, or atomic transformation, he might have applauded, but not atomic fission, or splitting the atom, of which he spoke in very critical terms.

43 According to Walter Schauberger, Viktor's machines were too inflexible, and could only function within a narrow margin of temperatures and speeds. This was not Viktor Schauberger's fault, as much as the shortcomings of a technology which could not construct 'machines' according to Nature's geometrical and dynamic systems.

44 Or as Walter Schauberger says: 'The heart doesn't pump, it is pumped!'

45 The version that Walter Schauberger tells of this experience of his father is slightly different. Viktor Schauberger received a pension as a result of a war wound from the First World War. All such pensioners were required

to have an examination every three years. On the day of his physical examination, he was having coffee in Berlin with a certain Mrs Mada Primavesi, an old friend who admired his work. During their conversation, Schauberger asked if she would mind waiting for twenty minutes, while he went for his triennial examination, which normally took only five minutes in a nearby clinic. After her fourth cup of coffee, Mrs Primavesi began to get upset, and after waiting 1 1/2 hours left for Schauberger's home. But his wife said that he had not returned. Mrs Primavesi became quite concerned, knowing that Schauberger was not one to break his word or behave irresponsibly.

Moving in the highest social circles of the Third Reich, Mrs Primavesi Schauberger was not to be found. Mrs Primavesi however, refused to leave the clinic until Schauberger's whereabouts had been accounted for. After further questioning of the staff yielded nothing, and there was no record of his appointment, Professor Fotzl and Mrs Primavesi made a room-to-room search of the whole clinic. Viktor Schauberger was eventually found in the lunatic section. He had been trussed up in a straight-jacket on a bed in a steel cage. He was outwardly quite calm, while the other lunatics around him rattled their cages in anger. Viktor Schauberger had determined to remain composed in the hope of being able to convince someone of his sanity.

He had been lured into the clinic in order to be disposed of quietly. In those days in Germany it was normal practice to inject lunatics with a lethal dose of sleeping drugs, so that the facilities could be put to better use. Viktor Schauberger would have fared likewise. Professor Fotzl insisted he knew nothing of this, and after many apologies, wrote out a certificate confirming Schauberger's sanity.

Had it not been for Mrs Primavesi's perseverance, and their fortunate meeting, Schauberger would have disappeared without a trace, to the This was only intended as a temporary measure, an excuse to get him into the army, so that he could be transferred to the Waffen SS under would set up a resonance with the contents and/or shape of the barrel, which would stimulate the molecular vibration of the contents.

46 This was only intended as a temporary measure, an excuse to get him into the army, so that he could be transferred to the Woffen SS under Himmler, which as a non-German or Austrian citizen, he could otherwise have resisted. He was never fit enough to fight

47 Through experience, the farmer would learn at what pitch his voice would set up a resonance with the contents and/or shape of the barrel, which would stimulate the molecular vination of the contents. This Tonsingen or 'singing to clay' would be done at specific times, such as immediately after planting and firming of the seed in the soil (roughly at Eastertime). The Tonsingen was generally ridiculed, so the farmers performed this practice in secret, so that it disappeared more and more from the knowledge of later generations.

The essential features of this practice were that, towards the evening

the clay loam should be stirred into cooling water with a large wooden spoon. When stirred towards the right, the mixing would be accompanied by ascending notes or cadences, and when stirred towards the left, with descending tones. The clay loam would be stimulated by a variety of vocal sounds. Due to the fermentation process taking place in cooling water in a state of darkness, the  $\text{CO}_2$  breathed out by the ferment, which is drawn towards the surface of the water by the loud singing, become bound.

Good clay contains aluminium, which, through being stirred to the sound of singing, becomes freely bound within the water in a very fine state. Early in the morning, the old farmer took his barrel out to the fields. He would take hold of a strong palm frond, and sprinkle the freshly rolled fields, as a priest does his communicants. In this way it was possible for the farmer to distribute over his land in very fine distillations.

48 The layer 'the virgin hymen' is a dielectric layer enabling the vegetation to act as a biocondenser. The condenser effect is achieved when the positive and negative charges are separated by a non-conducting (dielectric) layer. The greater the positive charge on one side of the condenser, so the negative charge on the other side will be increased, the two opposite charges tending always to equalize.

50 A high grade molecular quality of the meal was achieved.

51 A super phosphate(an artificial fertilizer) which is obtained through heat processes which destroy many molecular and trace elements.



# BIBLIOGRAPHY

Abbreviations: WG: for the periodical Weltgewissen (Worldknown)

I: for the periodical Implosion

KE: for the periodical Kosmische Evolution

Alexandersson, O.: "Arvet fran Viktor Schauburger" Halsa (Health magazine)

"Bioteknik eller Livet" Halsa: 9, 1959

"Den hemlighetsfulla kraften" Halsa: 8, 1959

"Det kalla vattnets dolda kraft" Halsa: 2, 1961

"Implosion contra explosion" Seklet: 4, 1965

"Kompendium i implosionsteknik" I-III

Brandstatter, L.: Implosion statt Explosion

Cibulka, H.: Den fruktbara trddgarden (The fruitful garden): ORBIO, Norrkoping

Corcoran, St. Clair B.: A General Spacial Model Jour, of Hydrology, vol.2, 1971, New Zealand

Drobeck, W.: Gedanken uber eine Grosstadt-Wasserversorgung (Ideas on the Water Supply for a Large Town): Das Gas und Wasserfach (Gas and Water Departments) 108, 1967. H 40, 52; 1968, H 8.

Hedin, S.: Stora Hastens flykt (The Flight of Large Horses): Stockholm, 1935.

Jager, H.: "Uberwindung der Atomspaltung durch organische Energierzeugung" (Overcoming Atom Splitting by the Generation of Organic Energy): WG, 12, 1957.

Kokaly, A: "Affaire Viktor Schauburger": WG: 12, 1959

"Energy aus dem All" (Energy from Everything): I: 41

"Das Erbe Viktor Schauburger" (The Inheritance of VS.): WG: 12, 1959

"Der goldene Pflub" (The Golden Plough): Neviges 1958

Der Lantdwirtschaft-Chemische Bundesversuchsanstalt, Linz: "Tatigkeitsbericht" (Activity Report) 1949-1952

Manteuffel-Szoeg, L.: "Das Herz ist keine Pumpe" (The Heart is not a Pump): KE: 2. 1971

Mathias, L: "World Forestry Charter Meeting": Trees and the New Earth: vol.XV, 1, 1951

Modern Earth, April 1960

Norling, G and Alexandersson, O: " Das entwickelte Wasserfadenversuch" (Developments in Water Capillary Research): 1, 6

Patent Applications made in Austria by Viktor Schauberger:

11 34 87: Einbau zu Wildbachverbaug (Construction of Apparatus for producing a Torrent) 1929

12 21 44: Künstliches Gerinne zum Schwemmen von Holz (Artificial Trough for Floating Wood) 1931

13 45 43: Wasserführung in Rohren und Gerinnen (Water Behaviour in Pipes and Troughs) 1933

13 62 14: Anlage und Einrichtungen zur Regelung des Abflussgerinnes von Staubecken (Layout and Arrangements for regulating the outflow trough at Staubecken) 1934

13 82 96: Wasserführung (Water Management) 1934

14 20 32: Verfahren zur Herstellung von ... Trinkwasser (Procedure for the Production of Drinking Water) 1935

16 66 44: Bodenbearbeitungsgerät (Apparatus for Soil Cultivation) 1959

19 66 80: Rohrleitung für flüssige und gasförmige Medien (Pipes for fluid and gaseous matter) 1959

"Zum Problem der Erdsatelliten" (Problems associated with Earth Satellites): WG: 11, 1957

Rusch, H.P.: Naturwissenschaft vom Morgen (Tomorrow's Natural Science): Frankfurt/Main

Schauberger, V.: "Atomwandlung statt Atomzertrümmerung" (Atom Transformation instead of Atom Destruction): I: 11/12

"Der Bauer und der Ochse" (The Farmer and the Oxen): I: 14

"Biologische Fruchtbau" (Biological Fruit Cultivation): I: 37

Letter to the Author, 1956

"Brief an Prof. Ude" (Letter to Prof. Ude): WG: 11/12, 1956

"Edeldüngung mit Hilfe planetaren Bewegung" (High Quality Dung with the Help of Planetary Movement): I: 45

"Ein kleiner Unterschied" (A Small Difference): I: 44

"Die erste biotechnische Praxis" (The first Biotechnical Practice): I: 7

"Die Flussregulierung" (River Control): I: 8

"Frequentes Wasser" (Abundance of Water): I: 24

"Die Geheimnisse des Wassers" (Secrets of Water): I: 46

"Das Geheimnis des Forellenmotors" (The Secret of the Trout Motor): I: 15

"Die Geniale Bewegungskraft" (The Genial Power of Movement): Neviges: 1959

"Der gestörte Kreislauf der Natur" (The Disturbed Cycle of Nature): I: 13

"Die Herstellung von Edelwasser" (Production of Pure Water): I: 13

"Ist der s.g. 'Lichtzuwachs' eine forstwirtschaftl. Errungenschaft?" (Does the so-called 'light growth' improve forestry?): I: 14

"Krebs, die Seuche der technischen eitalters" (Cancer, the pestilence of the technically pure age): I: 29

"Meine Begegnung mit Adolf Hitler" (My Meeting with Adolf Hitler): I: 23

"Die Natur als Lehrmeisterin" (Nature as Instructress): I: 7

"Naturnahe Landwirtschaft" (Near-to-Nature Agriculture): I: 20

"Das Problem der Donauregulierung" (The Problem of Controlling the Danube): I: 23

- "Das Ratsel Wasser" (The Water Puzzle): not published
- "Das Regenwurmersanatorium" (The Earthworm Sanatorium): I: 21
- "Die Repulsine" (The Repulsine? Repulsator): I: 45
- "Steht die Naturwissenschaft vor der Umkehr?" (Are the Natural Sciences at the Crossroads?): WG 2, 1958
- "Der sterbende Wald" (The Dying Forest): I: 20
- "Verfahren und Einrichtungen zur Durchführung organischer Synthesen" (The Techniques of Implementing Organic Synthesis): I: 19
- "Wir bewegen falsch" (We move in the wrong direction): I: 19
- "Temperatur und Wasserbewegung" (Temperature and Water Movement): Die Wasserwirtschaft: 20, 24, 35; 1930 and 3, 5, 9, 10: 1931
- Schauberger, W.: "Das Biophysikalische Prinzip der Bodenfruchtbarkeit und des Wasserhaushaltes (The Biophysical Principle of Soil Fertility and Water Husbandry): I: 9
- "Geräte zur Spurenelementdüngung" (Apparatus for Trace Element Manure Production): I: 23
- Schauberger, W. & Harthun, N.: "Die scheinbare Dichtesteigerung von Wasser im Einrollwirbel" (The apparent increase in Water Density in Simple Whirlpools): KE: 4, 1969
- "Der Tod des Viktor Schauburger" (The Death of V.S.): Neue Illustrierte Wochenachau: 8, 1959
- "Viktor Schauburger und die wissenschaftliche Bwisführung" (V.S. and the Direction of Science): Der Kraftquell: July 1959
- "Viktor Schauburger- Bund" (V.S. Group) WG: 11, 1957
- "Viktor Schauburger- was ist geschehen?" (V.S. - What has Happened?): WG: Nov-Dec 1958
- "Viktor Schauburger und die Biotechnik" (V.S. and Biotechnology): Der Kraftquell: July 1959
- Zimmermann, W.: "Viktor Schauburger": WG: March, April, May, 1958